



***AXIOMTEK***

## **IC0320-83C Series**

**Robust Din-rail Fanless Embedded  
System**

**User's Manual**



## **Disclaimers**

This manual has been carefully checked and believed to contain accurate information. Axiomtek Co., Ltd. assumes no responsibility for any infringements of patents or any third party's rights, and any liability arising from such use.

Axiomtek does not warrant or assume any legal liability or responsibility for the accuracy, completeness or usefulness of any information in this document. Axiomtek does not make any commitment to update the information in this manual.

Axiomtek reserves the right to change or revise this document and/or product at any time without notice.

No part of this document may be reproduced, stored in a retrieval system, or transmitted, in any form or by any means, electronic, mechanical, photocopying, recording, or otherwise, without the prior written permission of Axiomtek Co., Ltd.

**©Copyright 2019 Axiomtek Co., Ltd.**

**All Rights Reserved**

**June 2019, Version A2**

**Printed in Taiwan**

## Safety Precautions

Before getting started, please read the following important safety precautions.

1. The ICO320-83C does not come equipped with an operating system. An operating system must be loaded first before installing any software into the computer.
2. Be sure to ground yourself to prevent static charge when installing the internal components. Use a grounding wrist strap and place all electronic components in any static-shielded devices. Most electronic components are sensitive to static electrical charge.
3. Disconnect the power cord from the ICO320-83C before making any installation. Be sure both the system and the external devices are turned OFF. Sudden surge of power could ruin sensitive components. Make sure the ICO320-83C is properly grounded.
4. Make sure the voltage of the power source is correct before connecting the equipment to the power outlet.
5. Turn OFF the system power before cleaning. Clean the system using a cloth only. Do not spray any liquid cleaner directly onto the screen.
6. Do not leave this equipment in an uncontrolled environment where the storage temperature is below  $-45^{\circ}\text{C}$  or above  $85^{\circ}\text{C}$ . It may damage the equipment.
7. Do not open the system's back cover. If opening the cover for maintenance is a must, only a trained technician is allowed to do so. Integrated circuits on computer boards are sensitive to static electricity. To avoid damaging chips from electrostatic discharge, observe the following precautions:
  - Before handling a board or integrated circuit, touch an unpainted portion of the system unit chassis for a few seconds. This will help to discharge any static electricity on your body.
  - When handling boards and components, wear a wrist-grounding strap, available from most electronic component stores.
8. Caution  
Risk of explosion if battery is replaced by an incorrect type dispose of used batteries according to the instructions.
9. Warning  
Hot Surface Do NoT Touch.  
Restricted access area: The equipment should only be installed in a Restricted Access Area.
10. This product is intended to be supplied by a Listed Power Adapter or DC power source, output meets SELV, rated 12-24Vdc, minimum 1.6-0.81A, Tma = 25 degree C, and the altitude of operation = 5000m.Supported POE rated 24Vdc, minimum 2.05A Tma = 25 degree C, and the altitude of operation = 5000m.  
If need further assistance with purchasing the power source, please contact to manufacturer for further information.

## **Classification**

1. Degree of protection against electric shock: not classified
2. Degree of protection against the ingress of water: IP40
3. Equipment not suitable for use in the presence of a flammable anesthetic mixture with air or with oxygen or nitrous oxide.
4. Mode of operation: Continuous
5. Type of protection against electric shock: Class I equipment

## **General Cleaning Tips**

You may need the following precautions before you begin to clean the computer. When you clean any single part or component for the computer, please read and understand the details below fully.

When you need to clean the device, please rub it with a piece of dry cloth.

1. Be cautious of the tiny removable components when you use a vacuum cleaner to absorb the dirt on the floor.
2. Turn the system off before you start to clean up the component or computer.
3. Never drop the components inside the computer or get circuit board damp or wet.
4. Be cautious of all kinds of cleaning solvents or chemicals when you use it for the sake of cleaning. Some individuals may be allergic to the ingredients.
5. Try not to put any food, drink or cigarette around the computer.

## Cleaning Tools

Although many companies have created products to help improve the process of cleaning your computer and peripherals users can also use household items to clean their computers and peripherals. Below is a listing of items you may need or want to use while cleaning your computer or computer peripherals.

Keep in mind that some components in your computer may only be able to be cleaned using a product designed for cleaning that component, if this is the case it will be mentioned in the cleaning.

- Cloth: A piece of cloth is the best tool to use when rubbing up a component. Although paper towels or tissues can be used on most hardware as well, we still recommend you to rub it with a piece of cloth.
- Water or rubbing alcohol: You may moisten a piece of cloth a bit with some water or rubbing alcohol and rub it on the computer. Unknown solvents may be harmful to the plastics parts.
- Vacuum cleaner: Absorb the dust, dirt, hair, cigarette particles, and other particles out of a computer can be one of the best methods of cleaning a computer. Over time these items can restrict the airflow in a computer and cause circuitry to corrode.
- Cotton swabs: Cotton swabs moistened with rubbing alcohol or water are excellent tools for wiping hard to reach areas in your keyboard, mouse, and other locations.
- Foam swabs: Whenever possible it is better to use lint free swabs such as foam swabs.



**Note:** *We strongly recommended that you should shut down the system before you start to clean any single components.*

### **Please follow the steps below:**

1. Close all application programs
2. Close operating software
3. Turn off power
4. Remove all device
5. Pull out power cable

## **Scrap Computer Recycling**

If the computer equipments need the maintenance or are beyond repair, we strongly recommended that you should inform your Axiomtek distributor as soon as possible for the suitable solution. For the computers that are no longer useful or no longer working well, please contact your Axiomtek distributor for recycling and we will make the proper arrangement.

## **Trademarks Acknowledgments**

Axiomtek is a trademark of Axiomtek Co., Ltd. IBM, PC/AT, PS/2, VGA are trademarks of International Business Machines Corporation.

Intel<sup>®</sup> and Celeron<sup>®</sup> are registered trademarks of Intel Corporation.

MS-DOS, Microsoft C and QuickBASIC are trademarks of Microsoft Corporation.

VIA is a trademark of VIA Technologies, Inc.

SST is a trademark of Silicon Storage Technology, Inc.

UMC is a trademark of United Microelectronics Corporation. Other brand names and trademarks are the properties and registered brands of their respective owners.

# Table of Contents

---

Safety Precautions .....	iii
Classification .....	iv
General Cleaning Tips .....	iv
Scrap Computer Recycling .....	vi
<b>CHAPTER 1 INTRODUCTION .....</b>	<b>1</b>
<b>1.1 General Description .....</b>	<b>1</b>
<b>1.2 System Specifications .....</b>	<b>2</b>
1.2.1 CPU .....	2
1.2.2 BIOS .....	2
1.2.3 System Memory .....	2
1.2.4 Display .....	2
1.2.5 Ethernet Ports .....	2
1.2.6 PSE PD Ports.....	3
1.2.7 Storages.....	3
1.2.8 Wireless .....	3
1.2.9 USB .....	3
1.2.10 COM .....	4
1.2.11 Power .....	4
1.2.12 Power & Reset Button .....	4
1.2.13 DIO .....	5
1.2.14 WatchDog Timer (WDT) .....	5
1.2.15 Restore BIOS Optimal Defaults (SW1) .....	5
1.2.16 System LED.....	5
1.2.17 Operation Temperature.....	6
1.2.18 Storage Temperature .....	6
1.2.19 Humidity .....	6
1.2.20 Weight.....	6
1.2.21 Dimensions .....	6
1.2.22 System I/O Outlets.....	6
<b>1.3 Dimensions .....</b>	<b>7</b>
<b>1.4 I/O Outlets .....</b>	<b>8</b>
<b>CHAPTER 2 HARDWARE INSTALLATION .....</b>	<b>11</b>
<b>2.1 Installing the Memory Module.....</b>	<b>11</b>
<b>2.2 Installing the mSATA .....</b>	<b>13</b>
<b>2.3 Installing Wireless Module .....</b>	<b>14</b>
<b>2.4 Installing Hard Disk .....</b>	<b>17</b>
<b>2.5 Installing Din-rail Mounting.....</b>	<b>18</b>
<b>CHAPTER 3 AMI UEFI BIOS UTILITY .....</b>	<b>19</b>
<b>3.1 Entering Setup .....</b>	<b>19</b>
<b>3.2 The Main Menu .....</b>	<b>19</b>
<b>3.3 Advanced Features .....</b>	<b>20</b>
<b>3.4 Chipset Feature.....</b>	<b>36</b>
<b>3.5 Security.....</b>	<b>37</b>

3.6	Boot Type .....	39
3.7	Save & Exit .....	41
<b>APPENDIX A WATCHDOG TIMER.....</b>		<b>43</b>
	About Watchdog Timer .....	43
	How to Use Watchdog Timer .....	43
<b>APPENDIX B POWER BUTTON SETTING FOR WINDOW SOFTWARE ...</b>		<b>45</b>



# CHAPTER 1

## INTRODUCTION

This chapter contains general information and detailed specifications of the ICO300. The Chapter 1 includes the following sections:

- General Description
- System Specification
- Dimensions
- I/O Outlets

### 1.1 General Description

The fanless embedded system ICO320-83C is an ideal solution for communications control and protocol converter applications in harsh environments. Designing for strict environment, ICO320-83C adapts with extra low power consumption Intel Celeron N3350 (1.1GHz/2-cores) processor, supporting industrial operating temperature range from -40°C to +70°C. ICO320-83C offers a wide selection of I/O function, including 2 x USB, 1 x VGA, 1 x COM port, 1 x CANBUS and 1 x DIO. Its compact size makes it suitable for DIN rail or wall mount, allowing user put into control cabinet easily. With the compatibility with Windows®10, ICO320-83C provides programmers with a friendly environment for developing application software at a lower cost.

ICO320-83C is a robust industrial-grade hardware design gateway and adopts the advanced cooling system, supporting the mSATA and 2.5" SATA SSD (or HDD) makes it especially suitable for field control & monitoring system solution for following markets such as:

Utility Industries (Water; Energy; Chemical Plant; Mining...)

Public Transportation Industries (Traffic/ Highway Control; Train/Bus Control...)

Homeland Security (Weather Monitoring/Alarm System...)

- **Features**

- Fanless design
- Wide temperature operation of -40°C - +70°C
- Supports 4 10/100/1000 Base-T Ethernet
- Supports 4 PSE PD compliant with IEEE802.3at standard through LAN1~4(Optional)
- 2 COM Ports support RS-232/422/485
- 1 Wireless (USB and PCIe Interface)
- Support one 2.5" SATA SSD(or HDD) and one mSATA(USB ,PCIe and SATA interface)
- Wide range 12~24V DC-in with terminal block (PSE only 24V)
- 8-bit programmable TTL level digital input/output ports
- Din-rail mounting
- Wall mounting (optional)
- Passed CE with FCC testing

- **Embedded O.S. Supported**

- ICO320-83C supports Windows<sup>®</sup> 10. For storage device, ICO320-83C supports one mSATA and SATA.

## 1.2 System Specifications

### 1.2.1 CPU

- Onboard Intel<sup>®</sup> Celeron N3350 (1.1 GHz/2-cores) processor.

### 1.2.2 BIOS

- AMI (American Megatrends Inc.) UEFI (Unified Extensible Firmware Interface) BIOS.

### 1.2.3 System Memory

- One DDR3L 204-pin SO-DIMM (1.35V) slot.
- Supports 1600 MHz max up to 8GB.

### 1.2.4 Display

- A slim type 15-pin D-Sub connector as VGA connector.
- Support VGA standards up to 1920x1200@60Hz

### 1.2.5 Ethernet Ports

- LAN Chip: Intel Ethernet Controller I210.
- Four RJ-45 connector, support 10/100/1000 Base-T Ethernet with 1.5KV magnetic isolated protection.

**1.2.6 PSE PD Ports**

- Compliant with IEEE 802.3at standard through LAN 1~4 ( Support total max 30W )

**1.2.7 Storages**

- 1 x mSATA (only half card)
- 1 x SATA.

**1.2.8 Wireless**

- 1 x Full size Mini Card slot supports module with USB and PCIe Interface.
- 1 x Half size Mini Card slot supports Module with USB, PCIe and SATA Interface.
- 1 x SIM Card Socket.
- 3 x Antenna holes.

**1.2.9 USB**

- 2 x USB3.0
- USB Pin Define :

Pin	Signal USB3.0 Port 0	Pin	Signal USB3.0 Port 1
1	VCC	10	VCC
2	D-	11	D-
3	D+	12	D+
4	GND	13	GND
5	SSRX2-	14	SSRX3-
6	SSRX2+	15	SSRX3+
7	GND	16	GND
8	SSTX2-	17	SSTX3-
9	SSTX2+	18	SSTX3+

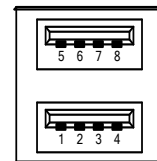

**1.2.10 COM**

- 4 ports DB9 support RS-232/422/485 which can be selected by BIOS.
- Supports Auto Flow Control in RS485 mode.
- Supports High Speed Mode 115.2 Kbps, Up to 1.5 Mbps
- Serial Port Pin Define: (DB9 Male) as below

COM1~4

Pin	RS-232	RS-422	RS-485
1	DCD	TX-	Data-
2	RXD	TX+	Data+
3	TXD	RX+	--
4	DTR	RX-	--
5	GND	GND	GND
6	DSR	--	--
7	RTS	--	--
8	CTS	--	--
9	RI	--	--

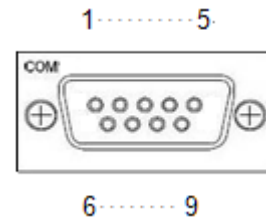

**1.2.11 Power**

- Wide-range 12 - 24V DC power input with terminal block.
- OVP and Reverse protection.

Pin	Signal
1	+
2	NC
3	-

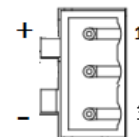

**1.2.12 Power & Reset Button**

- AT auto power on
- Power button setting for software must be set up firstly.
- One Reset Button



**Note:** Power button setting for Window software is offered on APPENDIX B for reference.

**1.2.13 DIO**

- One DB9 female connector supports 8 bits TTL level programmable digital input/output
- The voltage of TTL is 5V
- The programming is as follow:
  - I/O sink current is 8~10mA (Output drive current  $\pm$  50 mA)
  - Input/Output can be programmed

Pin	Signal
1	DIO0
2	DIO1
3	DIO2
4	DIO3
5	DIO4
6	DIO5
7	DIO6
8	DIO7
9	GND

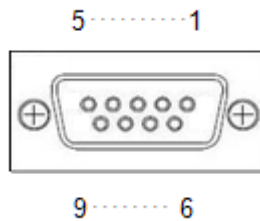

**1.2.14 WatchDog Timer (WDT)**

- 1~255 seconds or minutes; up to 255 levels.

**1.2.15 Restore BIOS Optimal Defaults (SW1)**

- Press the tact switch (SW 1) can restore BIOS optimal defaults.



**1.2.16 System LED**

- There are showed the LED's indicators and functional descriptions.

LED Name	Description	Color
ACT	Indicate the storge status and it's flashing when storge access.	Orange
PWR	Indicate the Power status. When the DC input is acceptable, the LED will ON.	Green

### 1.2.17 Operation Temperature

- -40°C ~ +70°C

### 1.2.18 Storage Temperature

- -40°C ~ +85°C

### 1.2.19 Humidity

- 10% ~ 95%

### 1.2.20 Weight

- ICO320-83C 0.692 kg
- ICO320-83C-POE 0.936 kg

### 1.2.21 Dimensions

- 48mm (1.22") (W) x110mm (3.93") (D) x155mm (4.92") (H)
- 77mm (1.22") (W) x110mm (3.93") (D) x155mm (4.92") (H) (PSE)

### 1.2.22 System I/O Outlets

- Two 9-pin D-Sub male connectors, COM1.COM2
- One 15-pin D-Sub female connector for VGA.
- Four 10/100/1000 Base-T RJ-45 with 1.5KV magnetic isolated protection.
- Four POE PD compliant with IEEE802.3at ( Optional ).
- Two USB 3.0 Ports
- One DC Power Input with terminal block.
- One 9-pin D-Sub Female connectors for DIO.
- Two Antenna holes.

### 1.3 Dimensions

The following diagrams show you dimensions and outlines of the ICO320-83C.

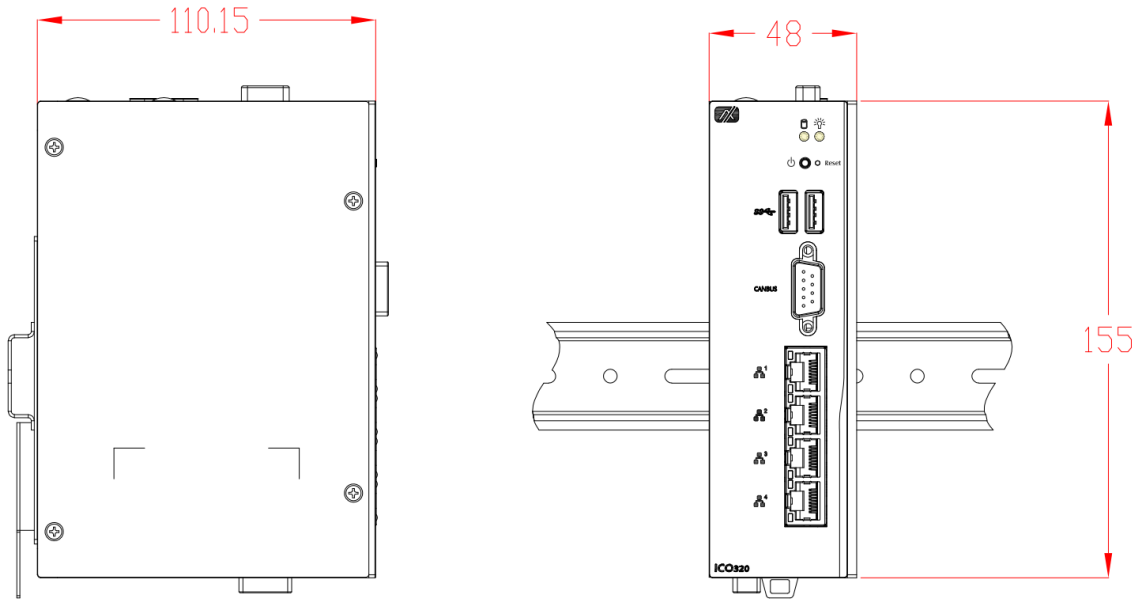

The following diagrams show you dimensions and outlines of the ICO320-83C-PSE

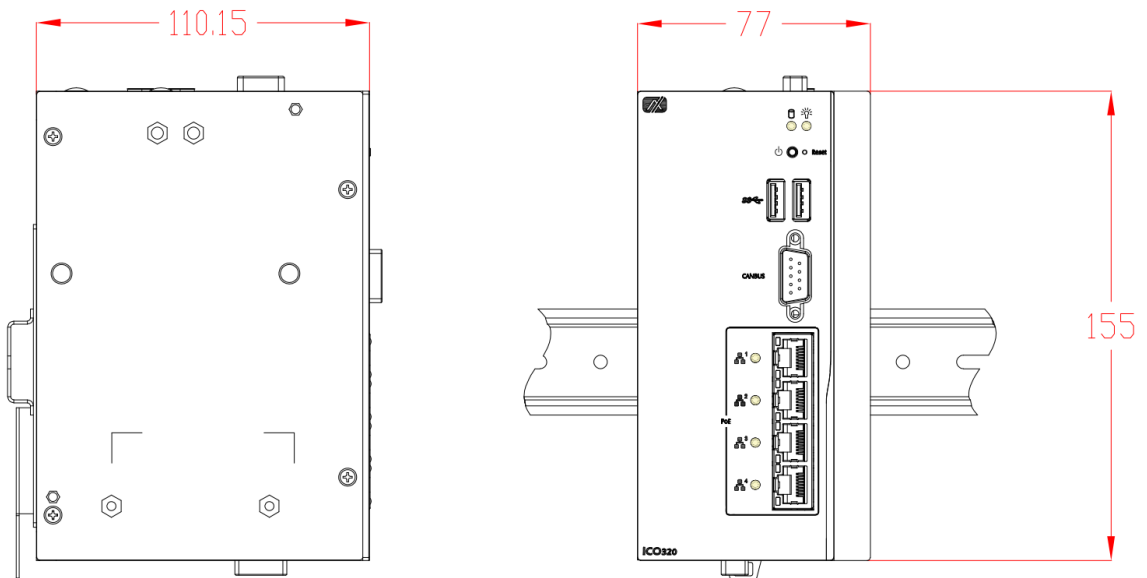

## 1.4 I/O Outlets

The following figures show you I/O outlets on front view and top view of the ICO320-83C.

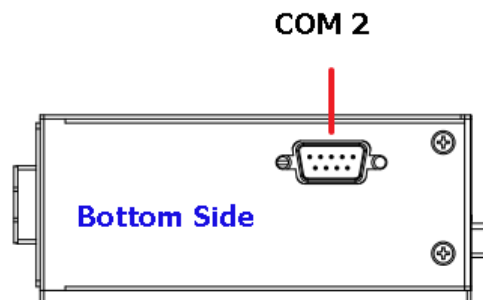
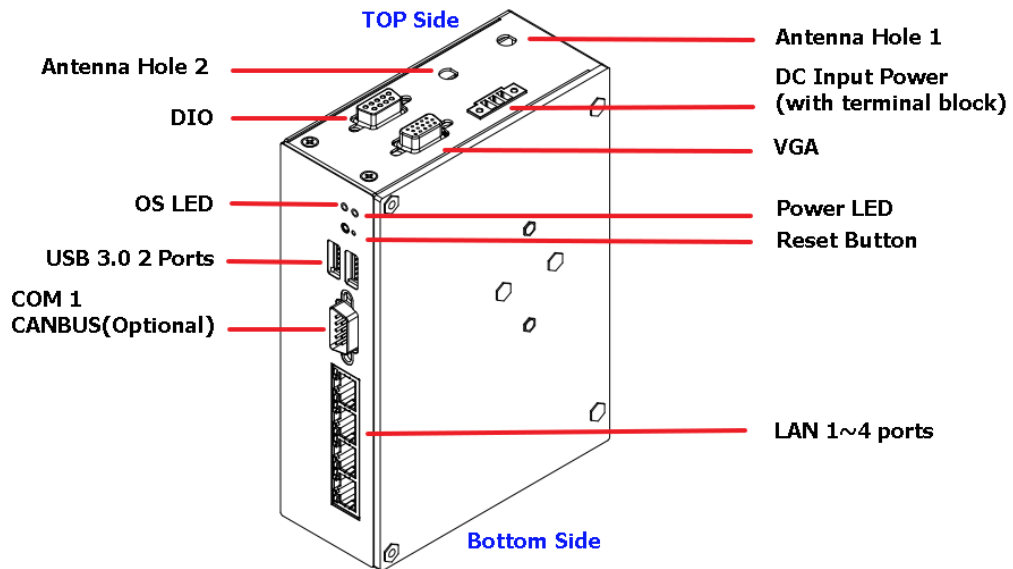



The following figures show you I/O outlets on front view and top view of the ICO320-83C-PSE.

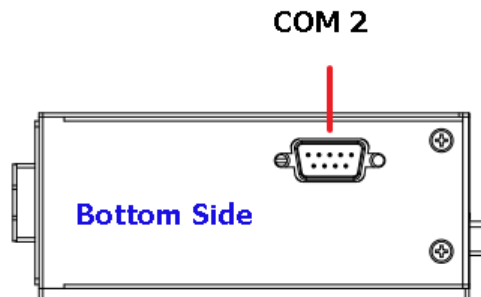
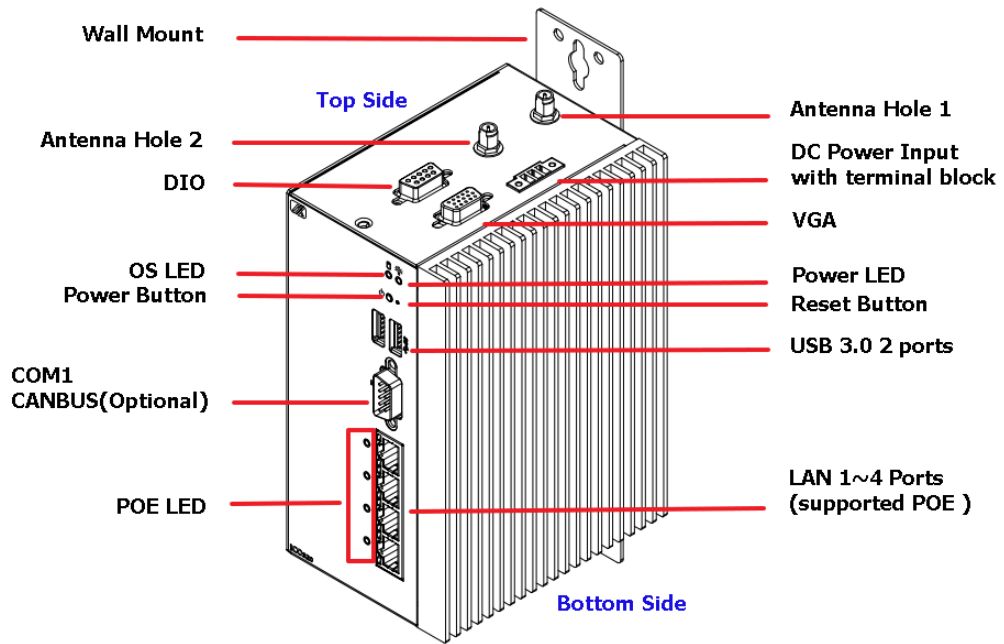

**This page is intentionally left blank.**

## CHAPTER 2 HARDWARE INSTALLATION

The ICO320-83C is convenient for your various hardware configurations, such as Memory Module and mSATA. The chapter 2 will show you how to install the hardware. It includes:

### 2.1 Installing the Memory Module

**Step 1** Turn off the system.

**Step 2** Loosen all screws of the cover and flip cover to the left.

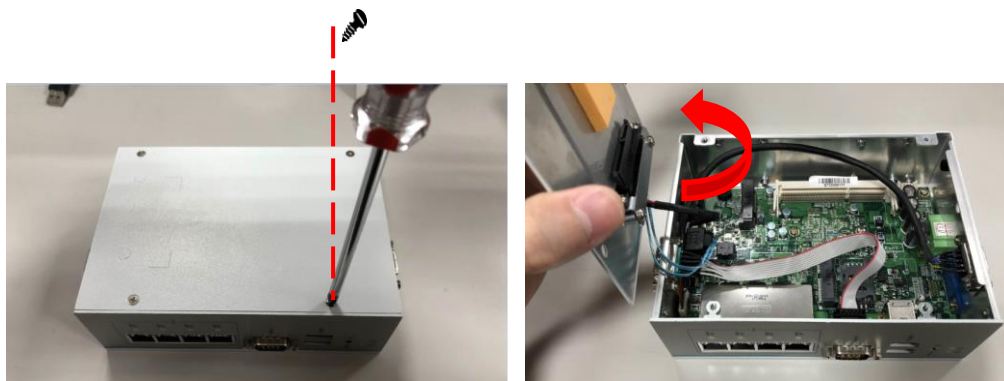

**Step 3** Put the thermal pad on memory module can increase cooling effect.



**Step 4** Use two fingers to hold the memory module, and insert the gold figure into the slot and push the module down.



**Step 5** The memory module is locked by two latches on the sides. We strongly recommend using “LDC737” silicone on the two sides of the memory for good ability of vibration.



**Step 6** Put the cover back to the system, and fasten screws tight close the chassis.

## 2.2 Installing the mSATA

**Step 1** Turn off the system.

**Step 2** Loosen all screws of the cover and flip cover to the left.

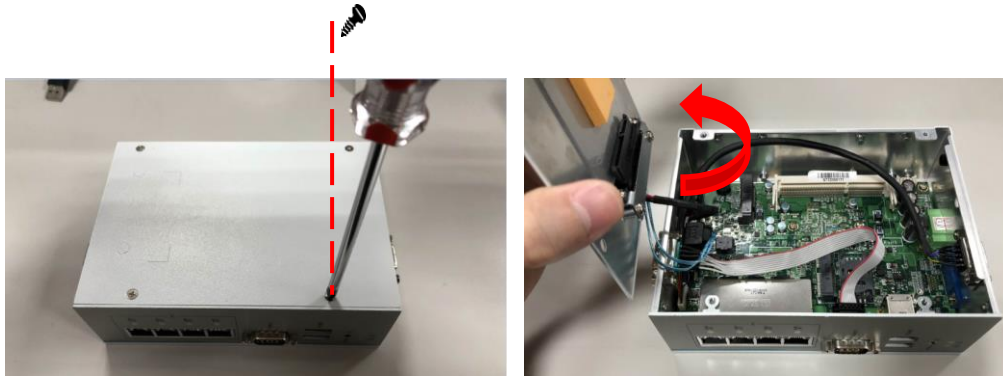

**Step 3** Insert the mSATA into the slot which marking with “mSATA / USB / PCIe”.

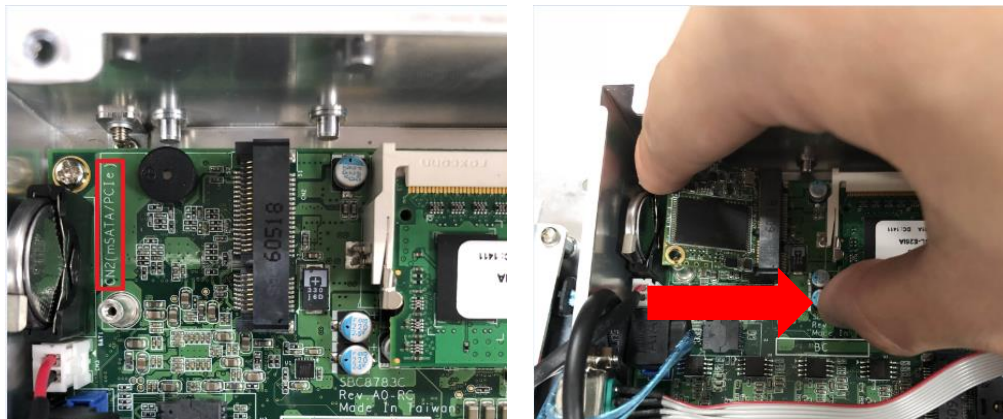

**Step 4** Fasten the screw tightly.

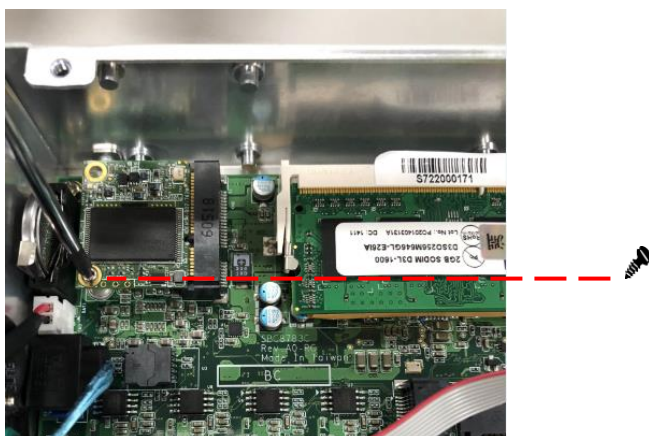



## 2.3 Installing Wireless Module

**Step 1** Turn off the system.

**Step 2** Loosen all screws of the cover and flip cover to the left.

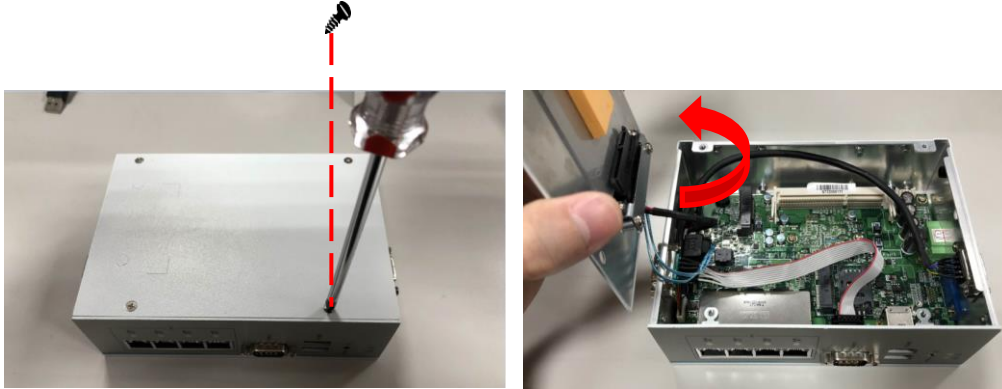

**Step 3** Following (Figure 3-1) push the SIM slot back to unlock SIM slot, inserting the SIM card and put it back(Figure 3-2), and lock the SIM slot (Figure 3-3).

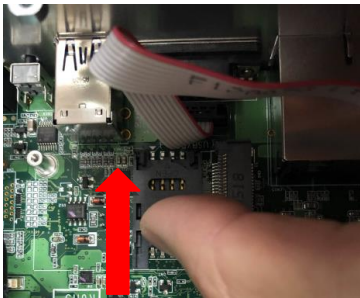

Figure 3-1

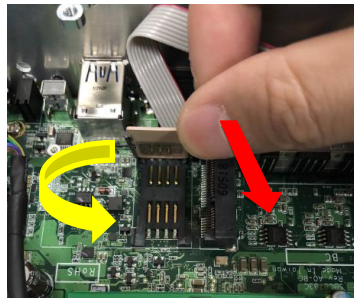
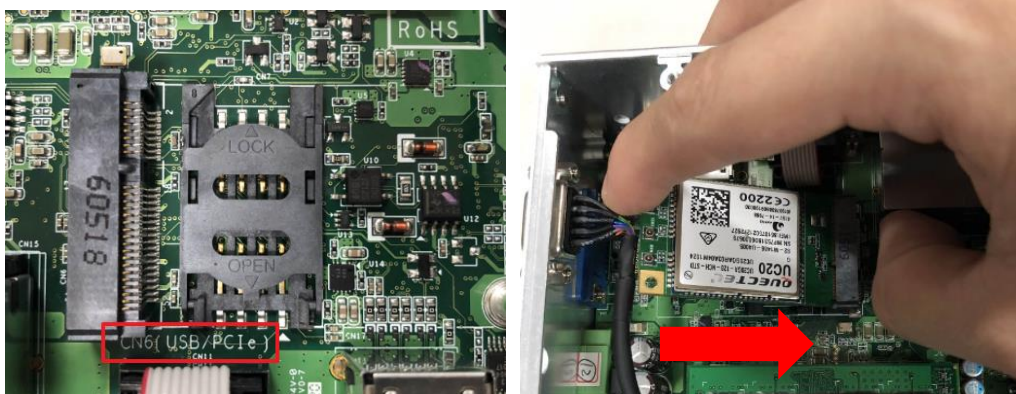

Figure 3-2



Figure 3-3

**Step 4** Insert the wireless module into the slot which marking with “USB / PCIe”.



**Step 5 Insert the 3G module and screws it tight.**



**Step 6 Removing the plug cover from the chassis.**

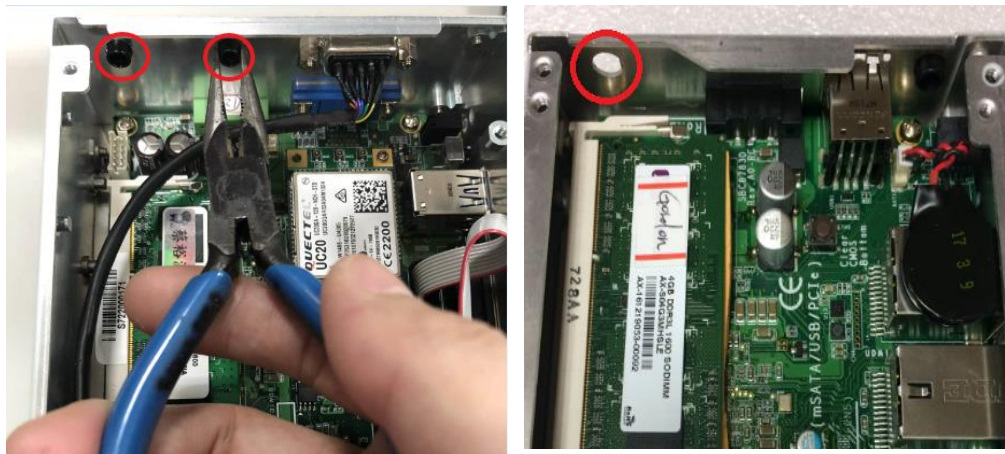

**Step 7 Connect the RF cable to the connector of 3G module which "MAIN".**



**Step 8** Taking out the parts from the 3G kit package (Figure 8-1) and make the RF cable through the antenna hole (Figure 8-2) and screw it tight (Figure8-3).



Figure 8-1

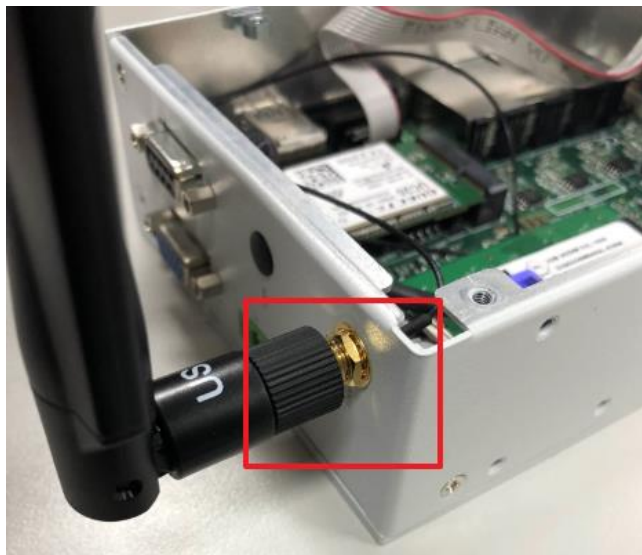

Figure 8-2



Figure 8-3

**Step 9** Screwing the RF antenna tight .



**Step 10** Put the cover back to the system, and fasten screws tight close the chassis.



**Note:** SIM Card only can use the standard size as the following pictures.

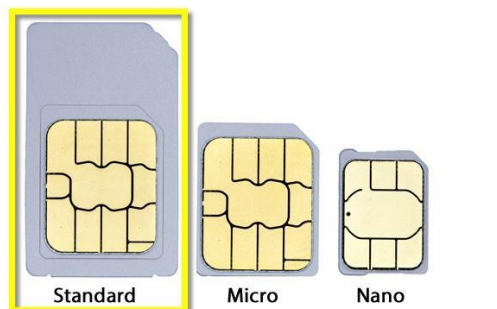



## 2.4 Installing Hard Disk

**Step 1 Turn off the system**

**Step 2 Loosen all screws of the cover and flip cover to the left.**

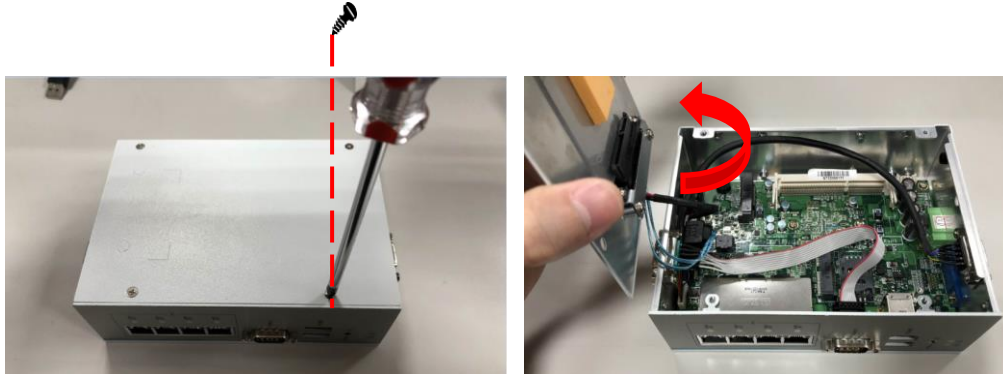

**Step 3 Loosen bracket screw and take off bracket.**



**Step 4 Insert hard disk and screwing bracket**

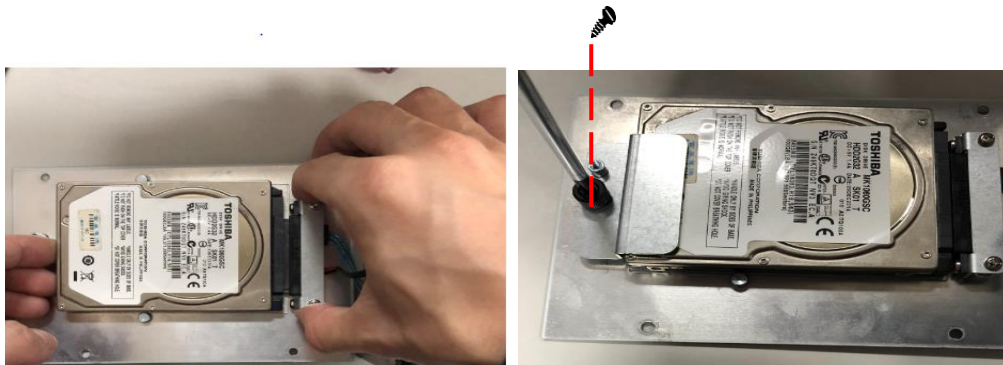

**Step 5 Put the cover back to the system, and fasten screws tight close the chassis.**

## 2.5 Installing Din-rail Mounting

The ICO320-83C provides Din-rail Mount for 2 methods that customers can install as below:

**Step 1 Prepare Din-rail Mount assembling components (screws and bracket) ready.**



 **Note:** ***Only** 4mm length M3 type screws can be accepted.*

**Step 2 Assembly the bracket to the system and fasten screws tight.**

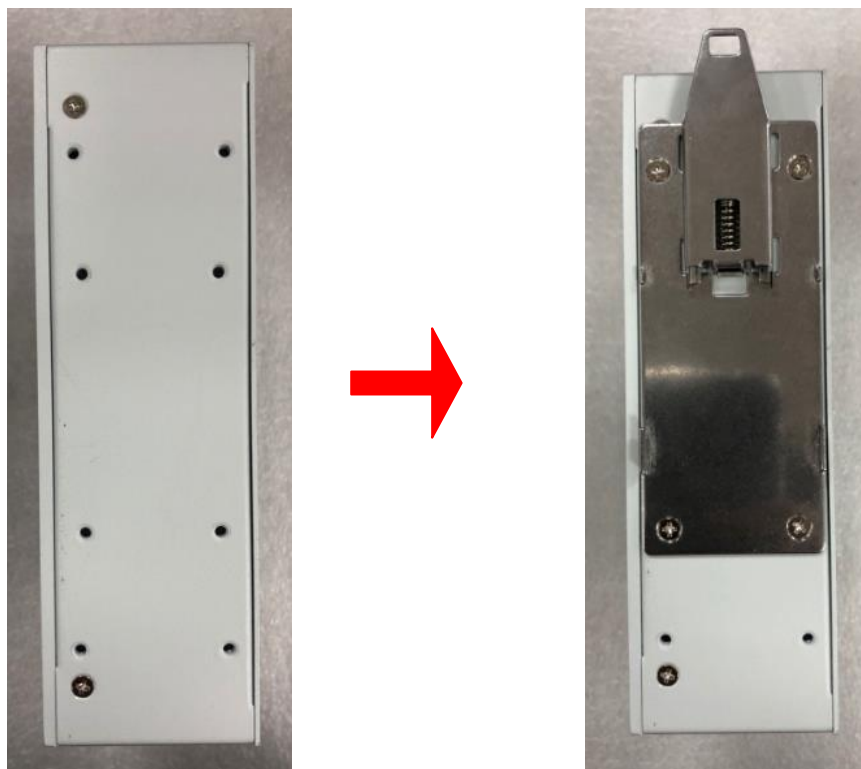

## CHAPTER 3 AMI UEFI BIOS UTILITY

The AMI UEFI BIOS provides users with a built-in Setup program to modify basic system configuration. All configured parameters are stored in a flash-backed-up to save the Setup information whenever the power is turned off.

### 3.1 Entering Setup

To enter the setup screens, follow the steps below:

1. Turn on the computer and press the <Del> key immediately.
2. After you press the <Del> key, the main BIOS setup menu displays. You can access the other setup screens from the main BIOS setup menu, such as the Advanced and Chipset menus.

### 3.2 The Main Menu

Once you enter the AMI BIOS Aptio Setup Utility, the Main Menu appears on the screen. In the Main Menu, there are several Setup functions and a couple of Exit options for your selection. Use Select Screen Keys (or Move Keys) to select the Setup Page you intend to configure then press <Enter> to accept or enter its sub-menu.



#### System Date

The date format is <day> <month> <date> <year>.

#### System Time

This item shows current time of your system with the format <hour> <minute> <second>. The time is calculated based on the 24-hour military-time clock. For example, 1 p.m. is 13:00:00.

### 3.3 Advanced Features

This Advanced section allows users to configure and improve your system, to set up some system features according to your preference. You can select any of the items in the left frame of the screen to go to the sub menus:

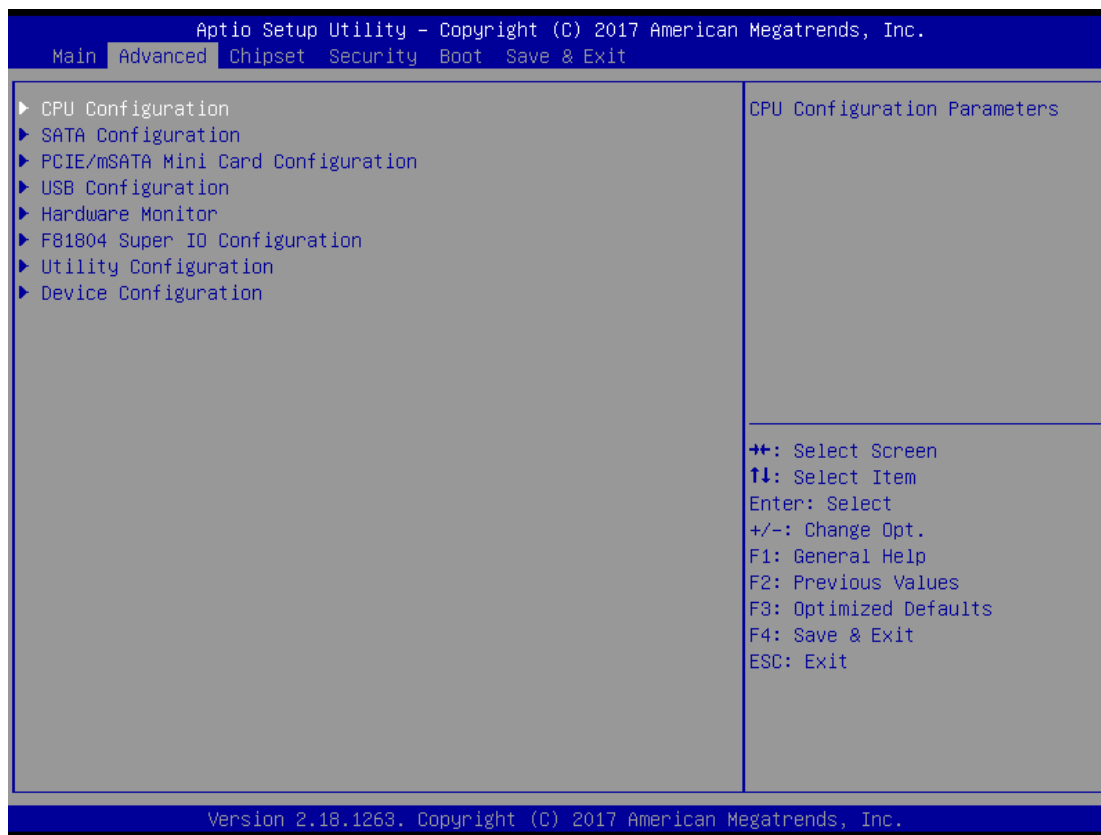

● **CPU Configuration**

Scroll to this item and press <Enter> to view the CPU Configuration informations.

(Please refer below graphics.)

Aptio Setup Utility - Copyright (C) 2017 American Megatrends, Inc.

Advanced

CPU Configuration		When enabled, a VMM can utilize the additional hardware capabilities provided by Vanderpool Technology
Intel(R) Celeron(R) CPU N3350 @ 1.10GHz		
CPU Signature	506C9	
Microcode Patch	20	
Max CPU Speed	1100 MHz	
Min CPU Speed	800 MHz	
Processor Cores	2	
Intel HT Technology	Not Supported	
Intel VT-x Technology	Supported	
64-bit	Supported	
L1 Data Cache		++: Select Screen ↑↓: Select Item Enter: Select +/-: Change Opt. F1: General Help F2: Previous Values F3: Optimized Defaults F4: Save & Exit ESC: Exit
L1 Code Cache		
L2 Cache		
L3 Cache		
Intel Virtualization Technology	[Enabled]	

Version 2.18.1263. Copyright (C) 2017 American Megatrends, Inc.

- **SATA Configuration**

Scroll to this item and press <Enter> to view the SATA Configuration informations.  
(Please refer below graphics.)

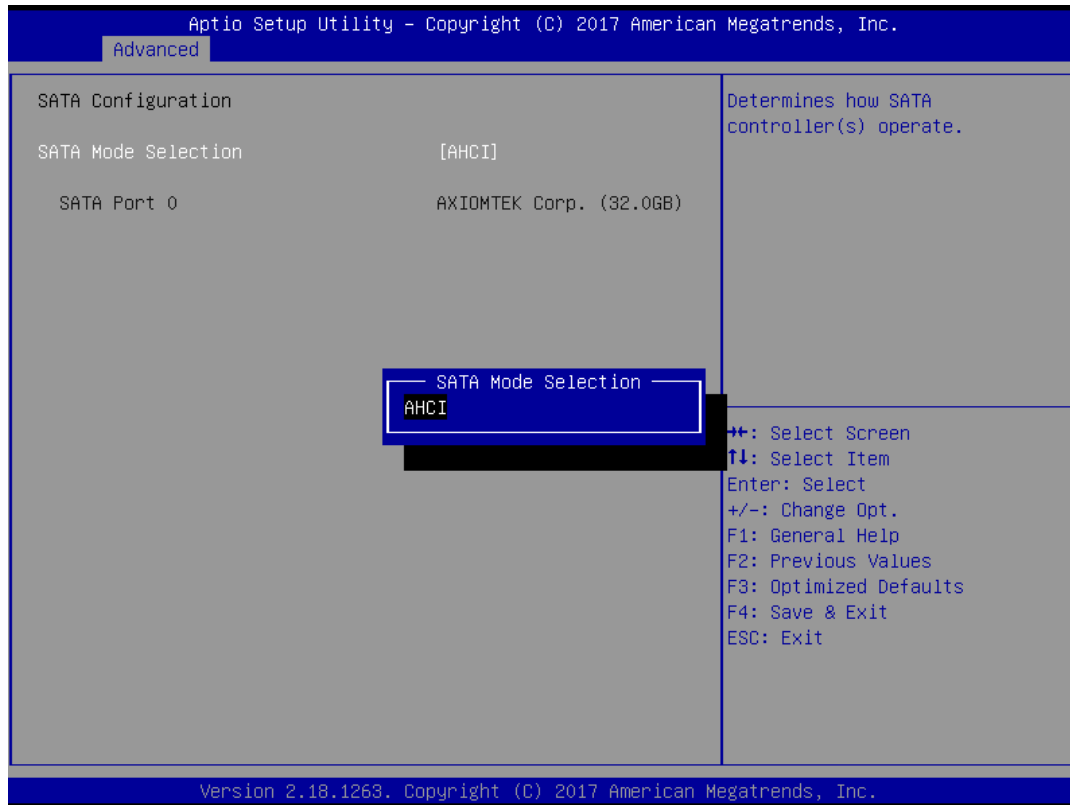
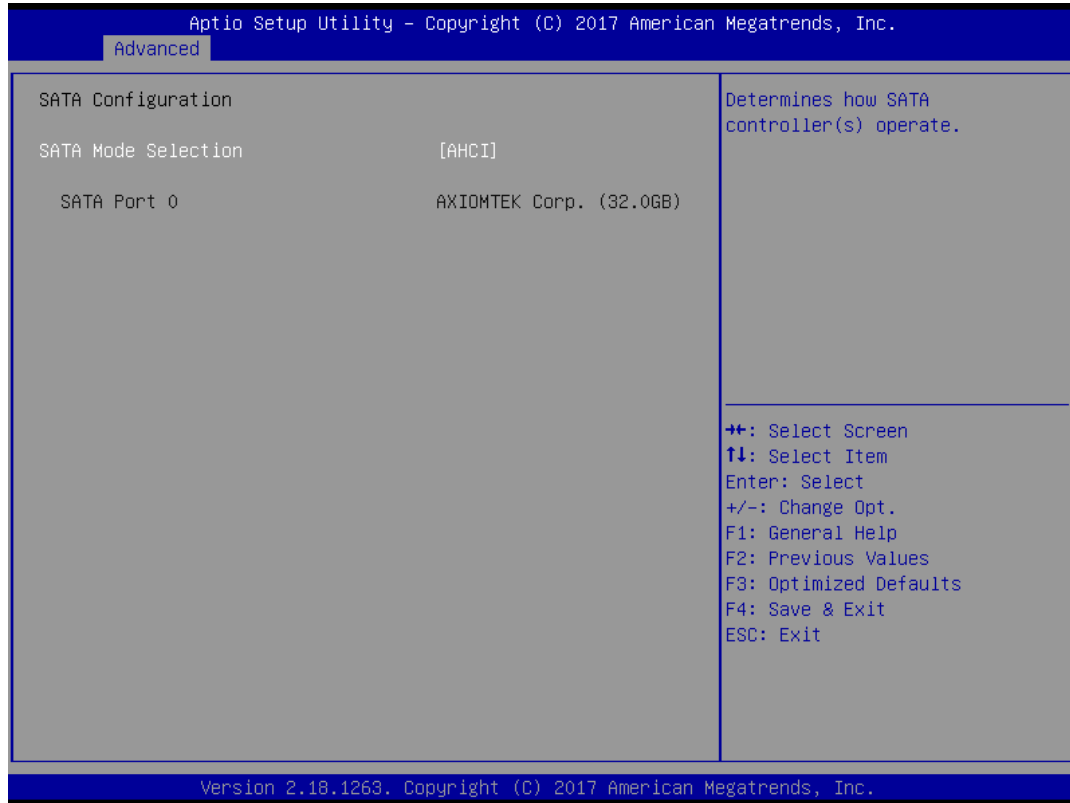

● **PCIe/mSATA Mini Card Configuration**

You can choose the PCIe or mSATA function, it can be select by BIOS menu.

(Please refer below graphics.)

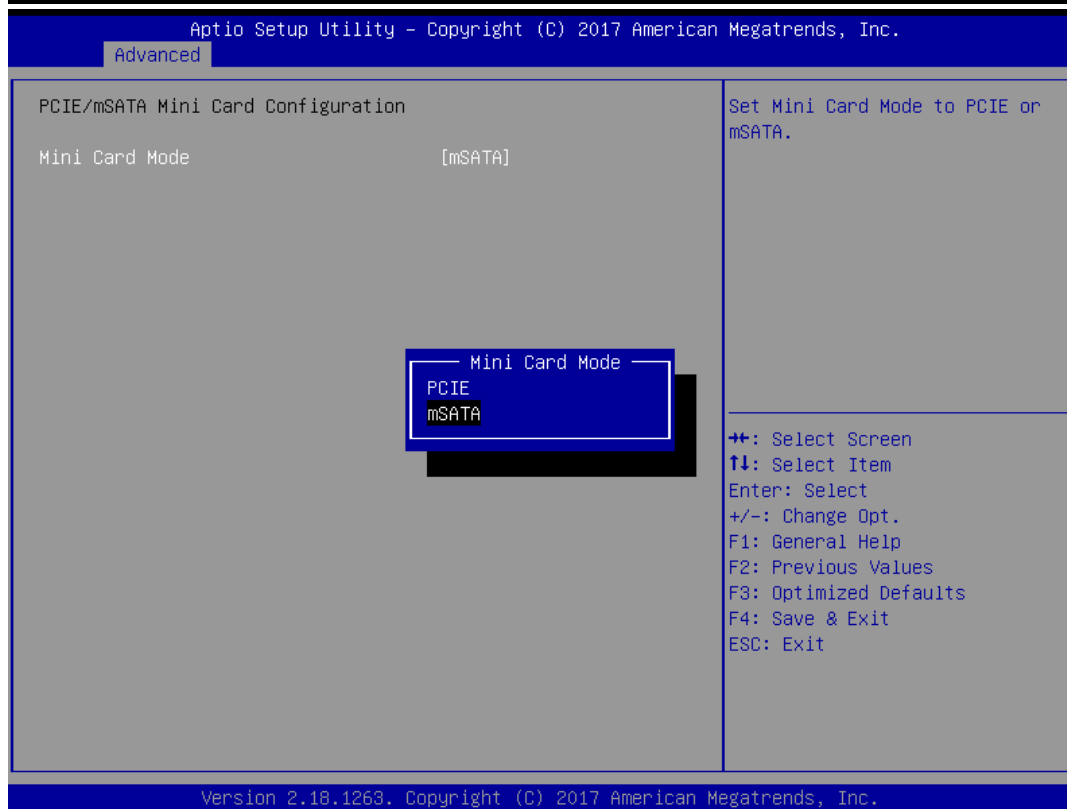
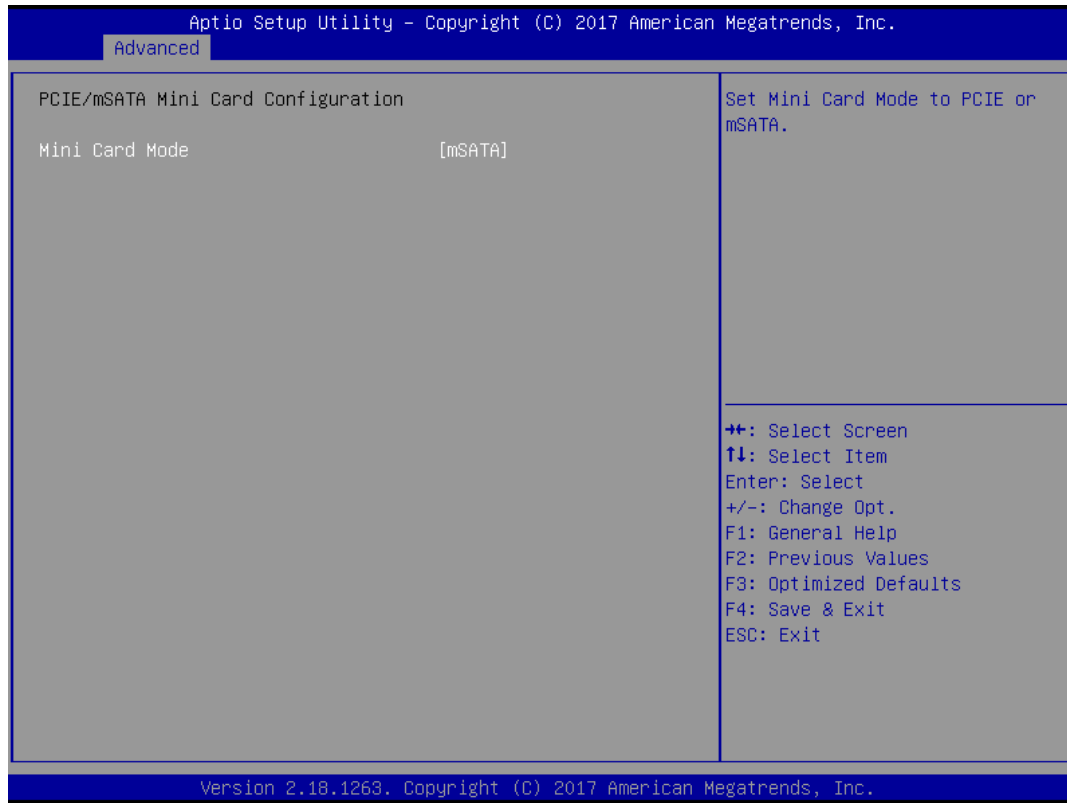

● **USB Configuration**

Scroll to this item and press <Enter> to view the USB Configuration informations.

(Please refer below graphics.)

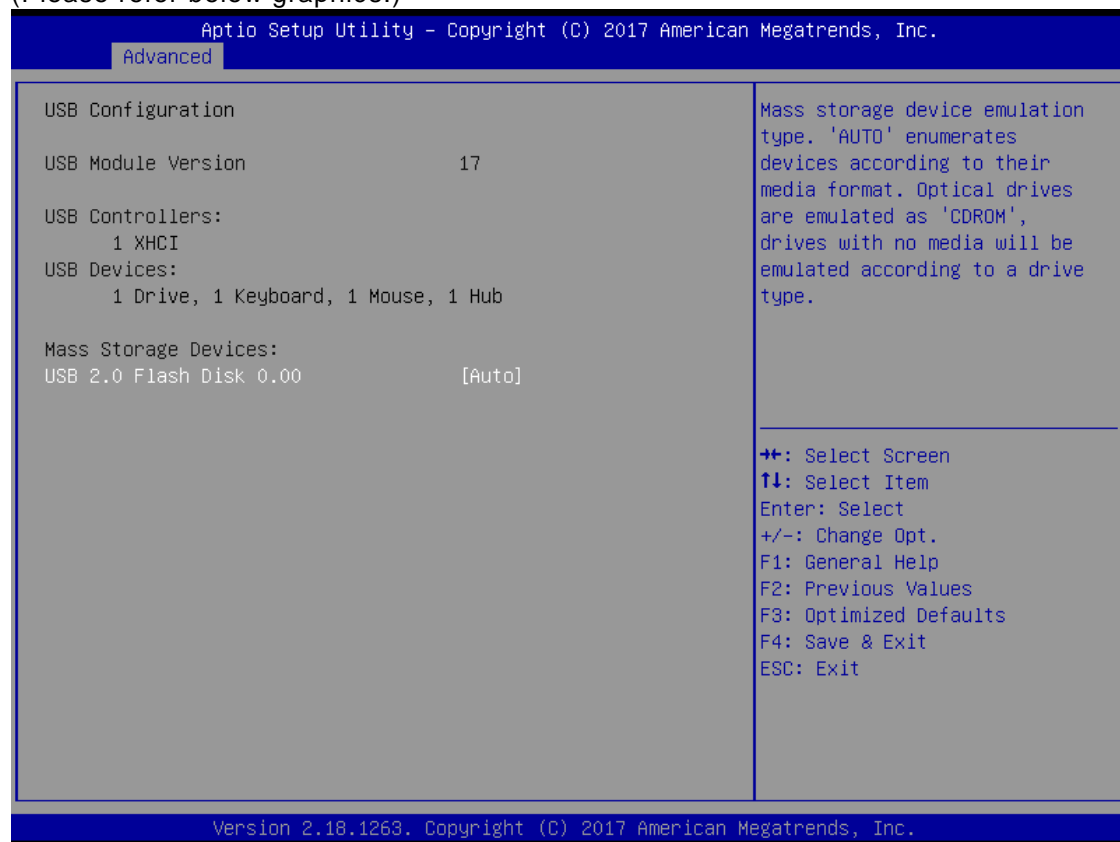



- **H/W Monitor**

Scroll to this item and press <Enter> to view the monitor hardware status.

(Please refer below graphics.)

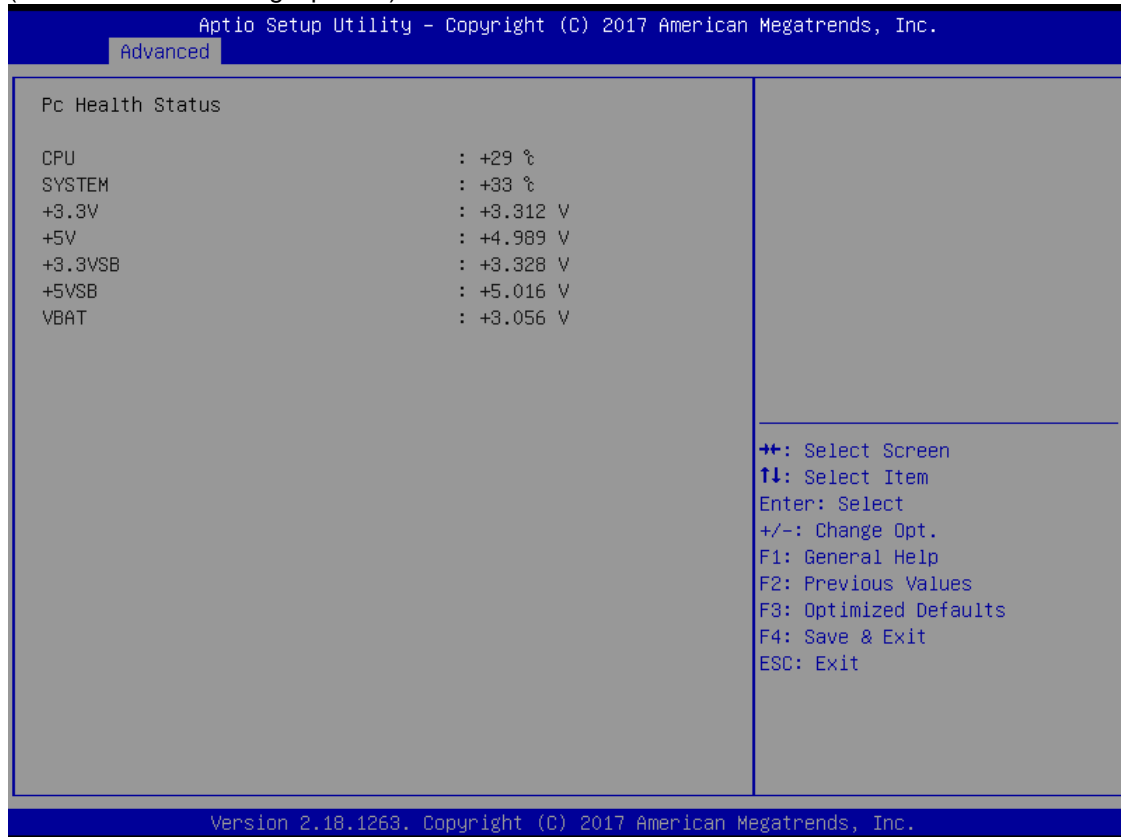

## F81804 Super IO Configuration

The default setting for all Serial Ports are RS232.

You can change the setting by selecting the value you want in each COM Port Type.

Support RS422 & RS485 mode and high speed mode.

You can enable to High-speed mode, it can be select by BIOS menu.

Com Port speed supports up to 1.5 Mbps.

(Please refer below graphics.)

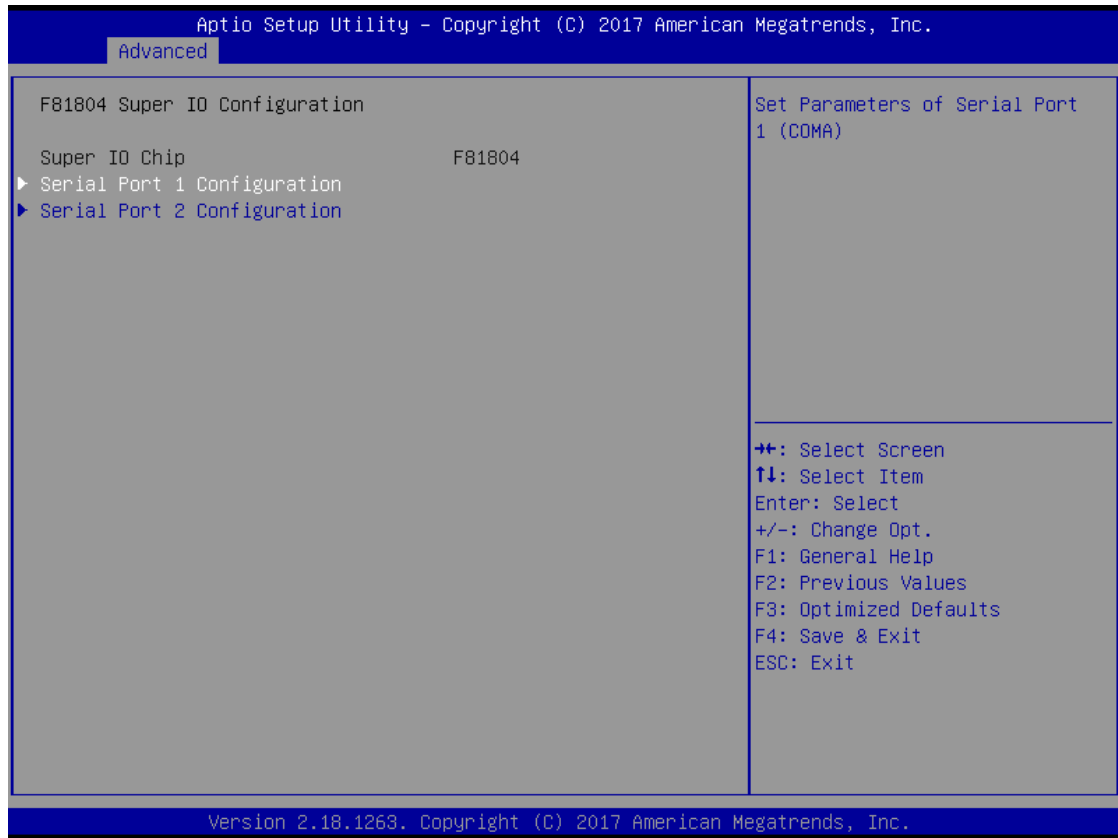

Aptio Setup Utility - Copyright (C) 2017 American Megatrends, Inc.

Advanced

Serial Port 1 Configuration	RS232/RS422/RS485
Device Settings	ID=3F8h; IRQ=4;
Select Mode	[RS232]
High-speed mode	[Disabled]

Select Mode

- RS232
- RS422
- RS485

++: Select Screen  
↑↓: Select Item  
Enter: Select  
+/-: Change Opt.  
F1: General Help  
F2: Previous Values  
F3: Optimized Defaults  
F4: Save & Exit  
ESC: Exit

Version 2.18.1263. Copyright (C) 2017 American Megatrends, Inc.

- **Serial Port Console Redirection**

The default setting for the console redirection function is [Disabled]

(Please refer below graphics.)



And you can further change the setting by selecting or setting the value you want in each function as the following pictures.

## ● Utility Configuration

BIOS flash utility is a tool for flash BIOS on setup menu, follow the step to flash BIOS.

1. Create a folder and rename to Axiomtek on the root of USB storage (Ex: X:\Axiomtek)
2. Copy BIOS file to the Axiomtek folder (Ex: X:\Axiomtek\SBC8783CX.004)
3. Enter the BIOS flash utility and locate the BIOS file.
4. Push "Start flash system BIOS"



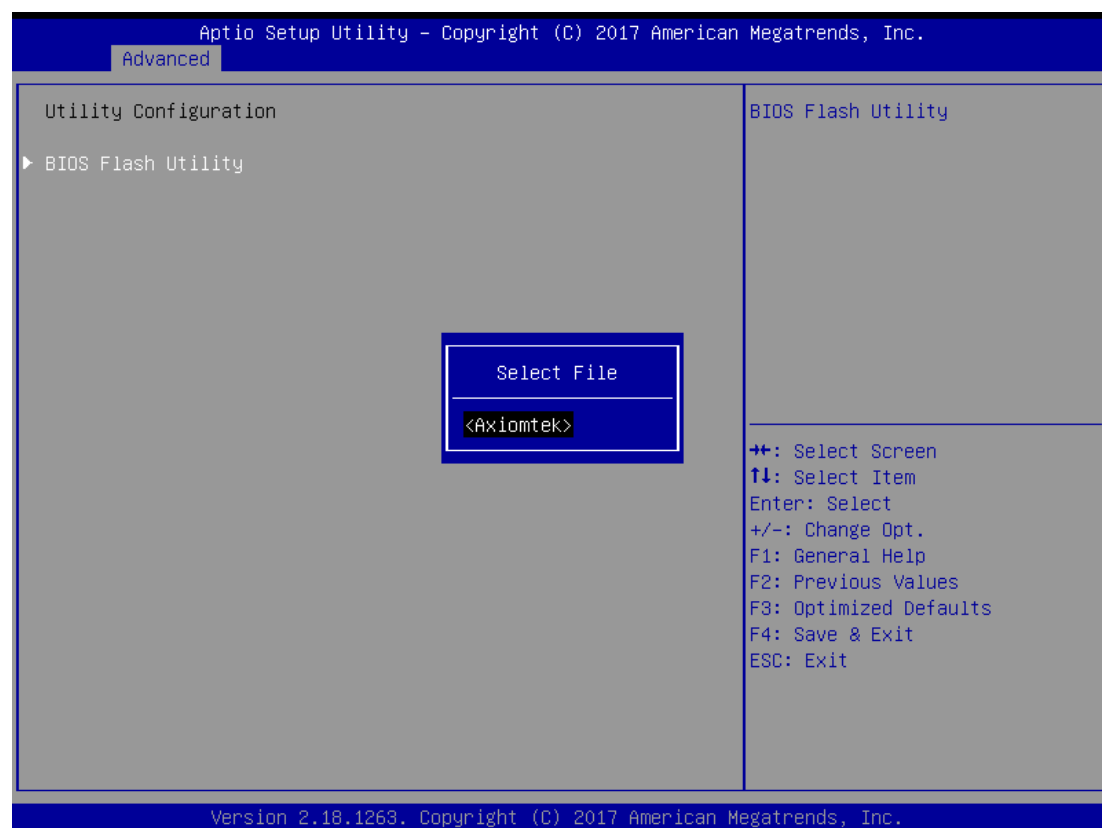
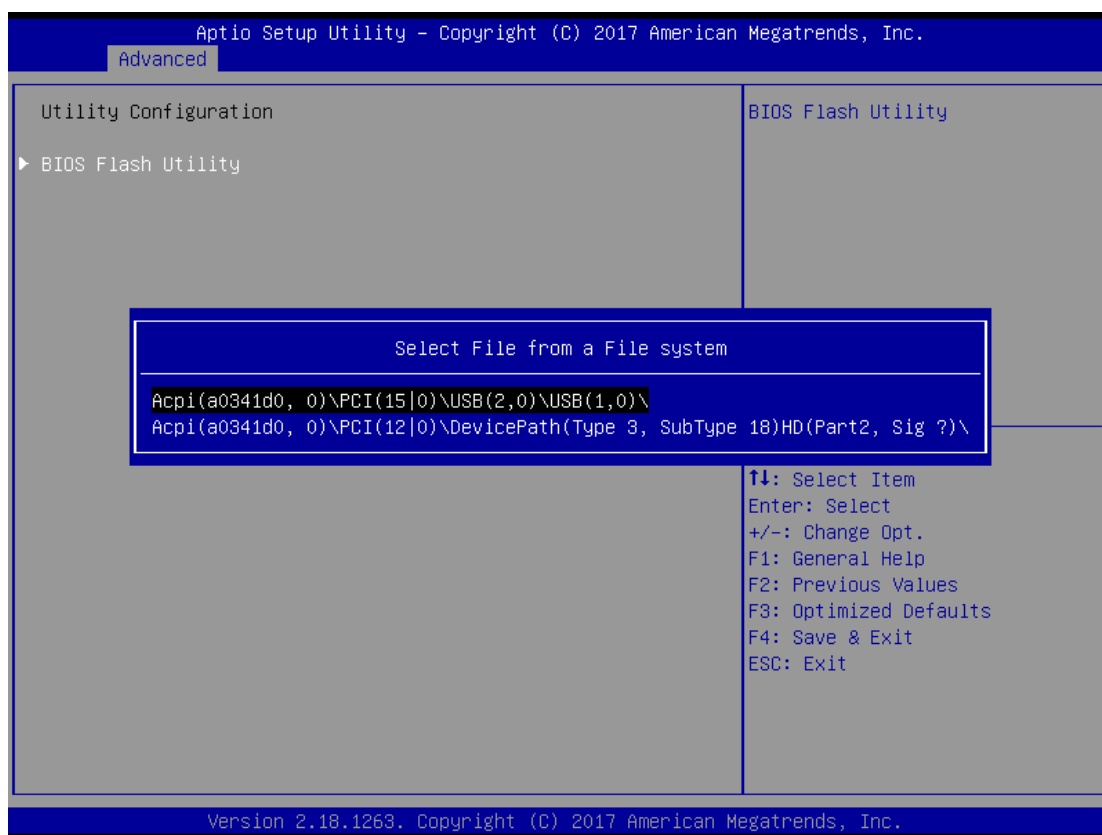

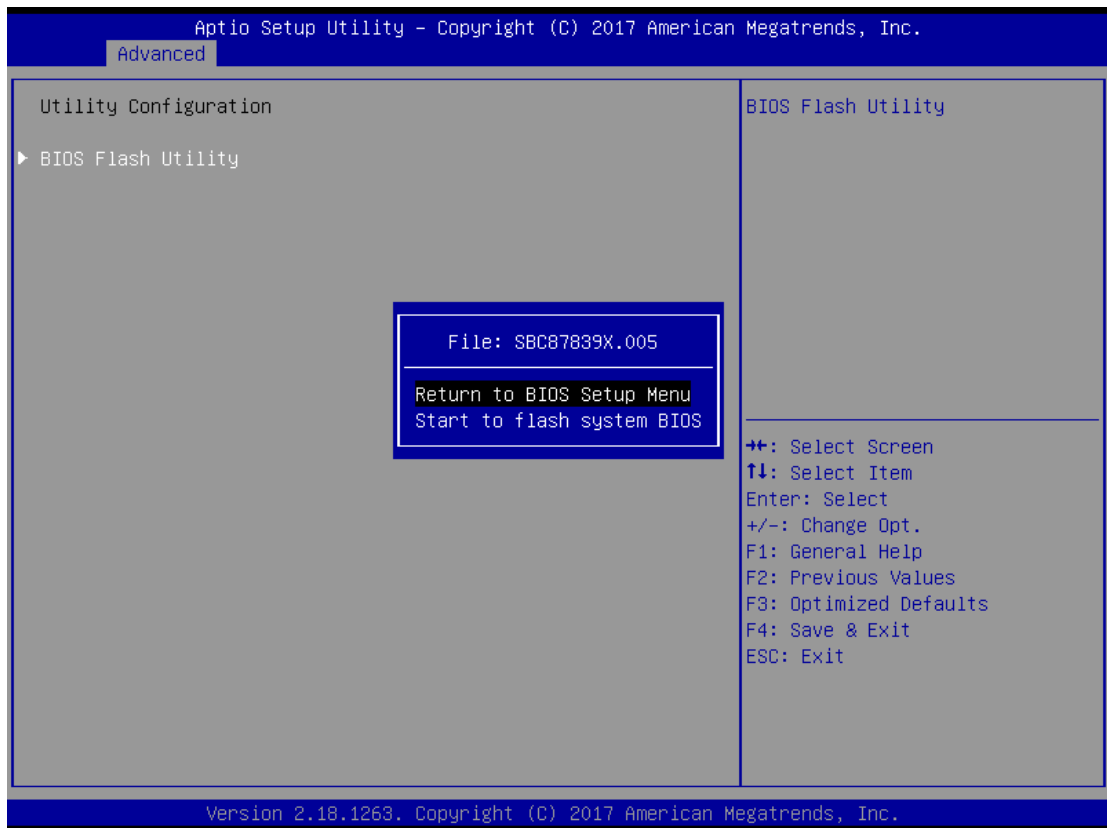
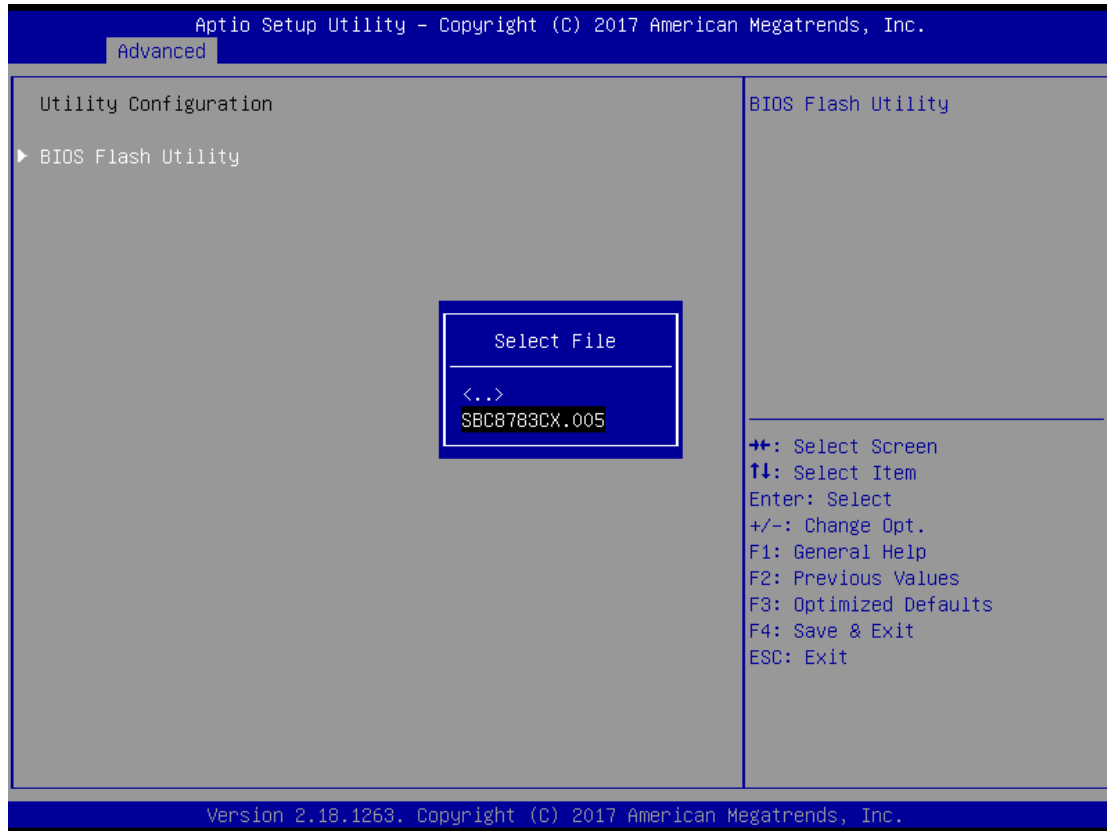

● **DIO Configuration**

The DIO Modifacation default setting is “disable”.  
 If the setting is changed for “enable”, you can load manufacture default and program DIO setting.

(Please refer below graphics.)

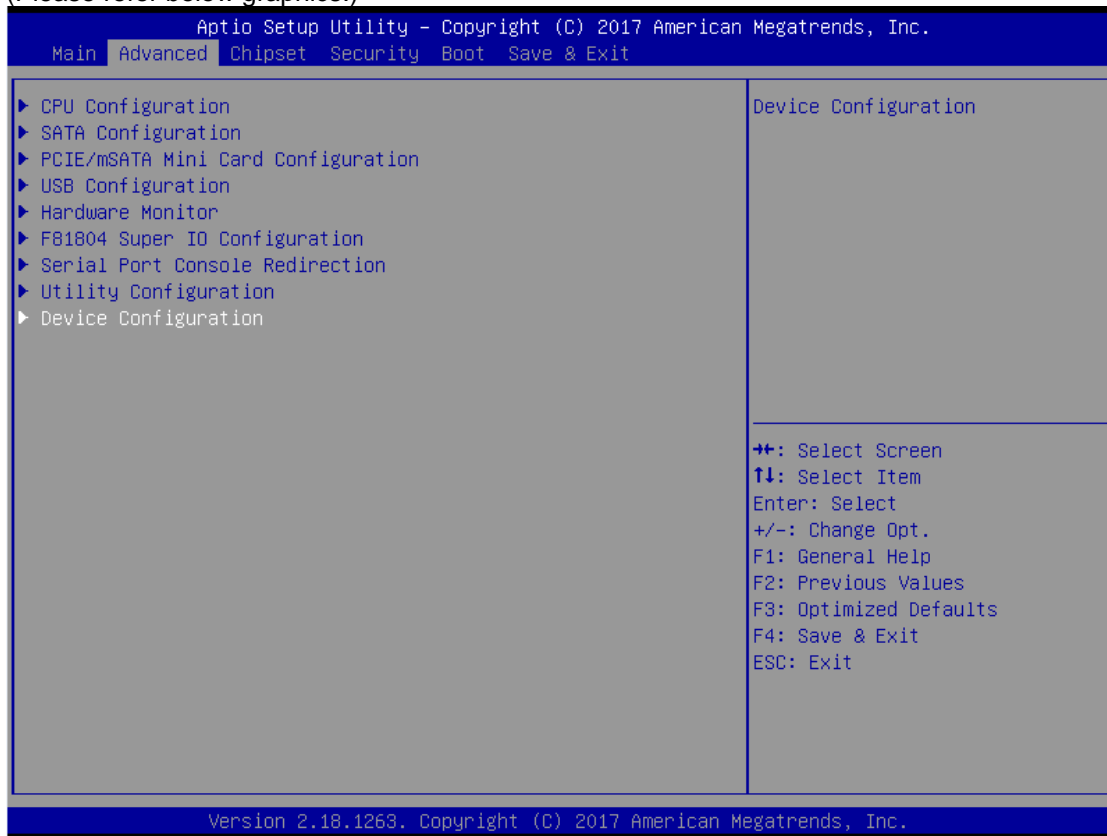



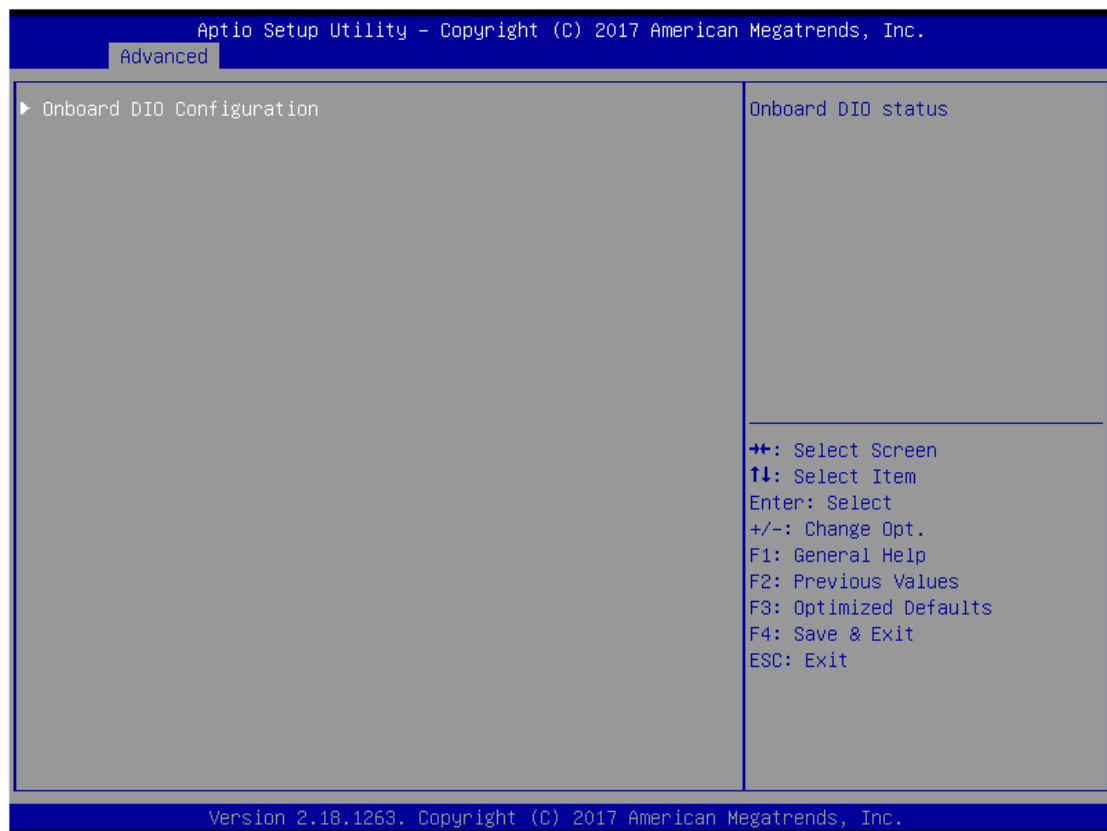

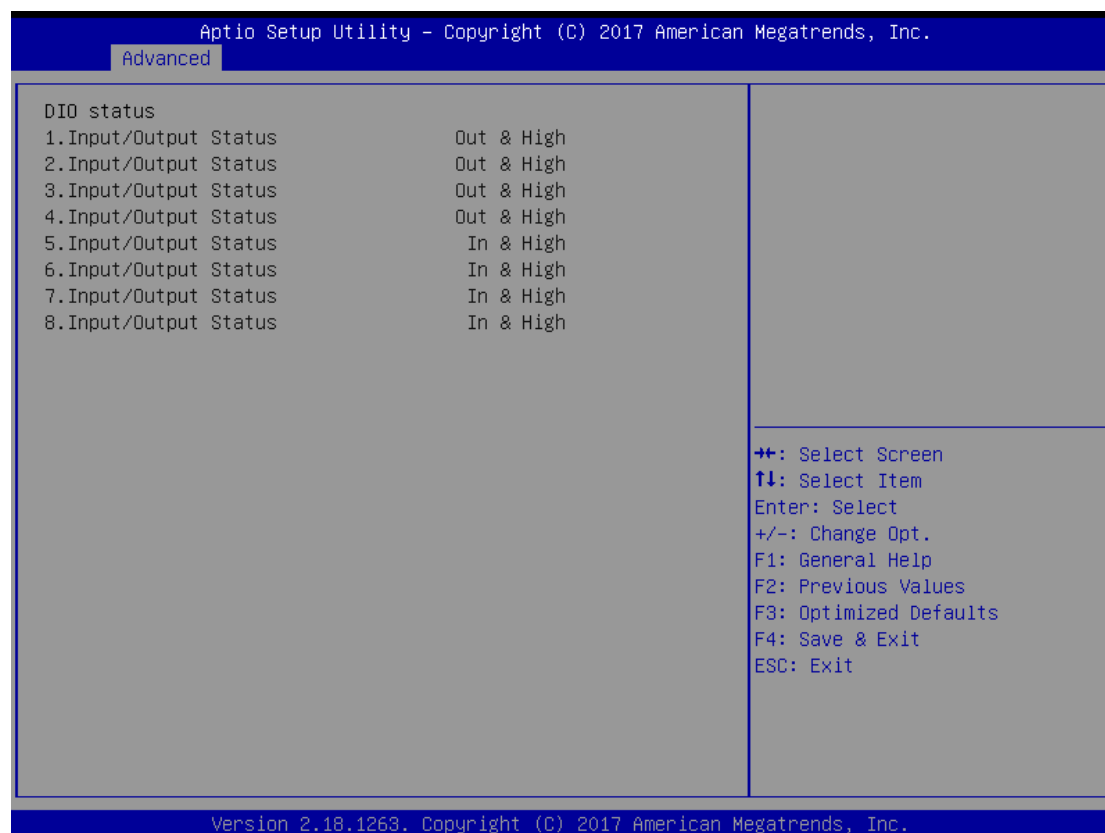

Aptio Setup Utility - Copyright (C) 2017 American Megatrends, Inc.

Advanced

<p>Onboard DIO Configuration</p> <p>DIO Modification [Enabled]</p> <p>▶ Load Manufacture Default</p> <p>▶ DIO port 1-8</p>	<p>Enabled or Disabled DIO Modification</p> <hr/> <p>↔: Select Screen              ↑↓: Select Item              Enter: Select              +/-: Change Opt.              F1: General Help              F2: Previous Values              F3: Optimized Defaults              F4: Save &amp; Exit              ESC: Exit</p>
--	--

Version 2.18.1263. Copyright (C) 2017 American Megatrends, Inc.

Aptio Setup Utility - Copyright (C) 2017 American Megatrends, Inc.

Advanced

<p>DIO status</p> <table style="width: 100%; border-collapse: collapse;"> <tr> <td style="width: 30%;">1. Input/Output Status</td> <td style="width: 30%;">Out &amp; High</td> <td style="width: 40%;"></td> </tr> <tr> <td>  Input/Output Setting</td> <td>[Output]</td> <td></td> </tr> <tr> <td>  High/Low Setting</td> <td>[High]</td> <td></td> </tr> <tr> <td>2. Input/Output Status</td> <td>Out &amp; High</td> <td></td> </tr> <tr> <td>  Input/Output Setting</td> <td>[Output]</td> <td></td> </tr> <tr> <td>  High/Low Setting</td> <td>[High]</td> <td></td> </tr> <tr> <td>3. Input/Output Status</td> <td>Out &amp; High</td> <td></td> </tr> <tr> <td>  Input/Output Setting</td> <td>[Output]</td> <td></td> </tr> <tr> <td>  High/Low Setting</td> <td>[High]</td> <td></td> </tr> <tr> <td>4. Input/Output Status</td> <td>Out &amp; High</td> <td></td> </tr> <tr> <td>  Input/Output Setting</td> <td>[Output]</td> <td></td> </tr> <tr> <td>  High/Low Setting</td> <td>[High]</td> <td></td> </tr> <tr> <td>5. Input/Output Status</td> <td>In &amp; High</td> <td></td> </tr> <tr> <td>  Input/Output Setting</td> <td>[Input]</td> <td></td> </tr> <tr> <td>6. Input/Output Status</td> <td>In &amp; High</td> <td></td> </tr> <tr> <td>  Input/Output Setting</td> <td>[Input]</td> <td></td> </tr> <tr> <td>7. Input/Output Status</td> <td>In &amp; High</td> <td></td> </tr> <tr> <td>  Input/Output Setting</td> <td>[Input]</td> <td></td> </tr> <tr> <td>8. Input/Output Status</td> <td>In &amp; High</td> <td></td> </tr> <tr> <td>  Input/Output Setting</td> <td>[Input]</td> <td></td> </tr> </table>	1. Input/Output Status	Out & High		Input/Output Setting	[Output]		High/Low Setting	[High]		2. Input/Output Status	Out & High		Input/Output Setting	[Output]		High/Low Setting	[High]		3. Input/Output Status	Out & High		Input/Output Setting	[Output]		High/Low Setting	[High]		4. Input/Output Status	Out & High		Input/Output Setting	[Output]		High/Low Setting	[High]		5. Input/Output Status	In & High		Input/Output Setting	[Input]		6. Input/Output Status	In & High		Input/Output Setting	[Input]		7. Input/Output Status	In & High		Input/Output Setting	[Input]		8. Input/Output Status	In & High		Input/Output Setting	[Input]		<p>Input/Output Setting</p> <hr/> <p>↔: Select Screen              ↑↓: Select Item              Enter: Select              +/-: Change Opt.              F1: General Help              F2: Previous Values              F3: Optimized Defaults              F4: Save &amp; Exit              ESC: Exit</p>
1. Input/Output Status	Out & High																																																												
Input/Output Setting	[Output]																																																												
High/Low Setting	[High]																																																												
2. Input/Output Status	Out & High																																																												
Input/Output Setting	[Output]																																																												
High/Low Setting	[High]																																																												
3. Input/Output Status	Out & High																																																												
Input/Output Setting	[Output]																																																												
High/Low Setting	[High]																																																												
4. Input/Output Status	Out & High																																																												
Input/Output Setting	[Output]																																																												
High/Low Setting	[High]																																																												
5. Input/Output Status	In & High																																																												
Input/Output Setting	[Input]																																																												
6. Input/Output Status	In & High																																																												
Input/Output Setting	[Input]																																																												
7. Input/Output Status	In & High																																																												
Input/Output Setting	[Input]																																																												
8. Input/Output Status	In & High																																																												
Input/Output Setting	[Input]																																																												

Version 2.18.1263. Copyright (C) 2017 American Megatrends, Inc.

### 3.4 Chipset Feature

This section contains completely optimized chipset's features in the system

Aptio Setup Utility - Copyright (C) 2017 American Megatrends, Inc.

Advanced

DIO status			Input/Output Setting
1. Input/Output Status	Out & High		
Input/Output Setting	[Output]		
High/Low Setting	[High]		
2. Input/Output Status	Out & High		
Input/Output Setting	[Output]		
High/Low Setting	[High]		
3. Input/Output Status	Out & High		
Input/Output Setting	[Output]		
High/Low Setting	[High]		
4. Input/Output Status	Out & High		
Input/Output Setting	[Output]		
High/Low Setting	[High]		
5. Input/Output Status	In & High		
Input/Output Setting	[Input]		
6. Input/Output Status	In & High		
Input/Output Setting	[Input]		
7. Input/Output Status	In & High		
Input/Output Setting	[Input]		
8. Input/Output Status	In & High		
Input/Output Setting	[Input]		

++: Select Screen  
 ↑↓: Select Item  
 Enter: Select  
 +/-: Change Opt.  
 F1: General Help  
 F2: Previous Values  
 F3: Optimized Defaults  
 F4: Save & Exit  
 ESC: Exit

Version 2.18.1263. Copyright (C) 2017 American Megatrends, Inc.

Aptio Setup Utility - Copyright (C) 2017 American Megatrends, Inc.

Chipset

Memory Information			
Total Memory	4096 MB		
Memory Slot0	4096 MB		

++: Select Screen  
 ↑↓: Select Item  
 Enter: Select  
 +/-: Change Opt.  
 F1: General Help  
 F2: Previous Values  
 F3: Optimized Defaults  
 F4: Save & Exit  
 ESC: Exit

Version 2.18.1263. Copyright (C) 2017 American Megatrends, Inc.

### 3.5 Security

The default setting for Administrator Password is "Not setting passwords".

The Security menu allows users to change the security settings for the system.

You can set the password for both Administrator Password and User Password.

(Please refer below graphics.)

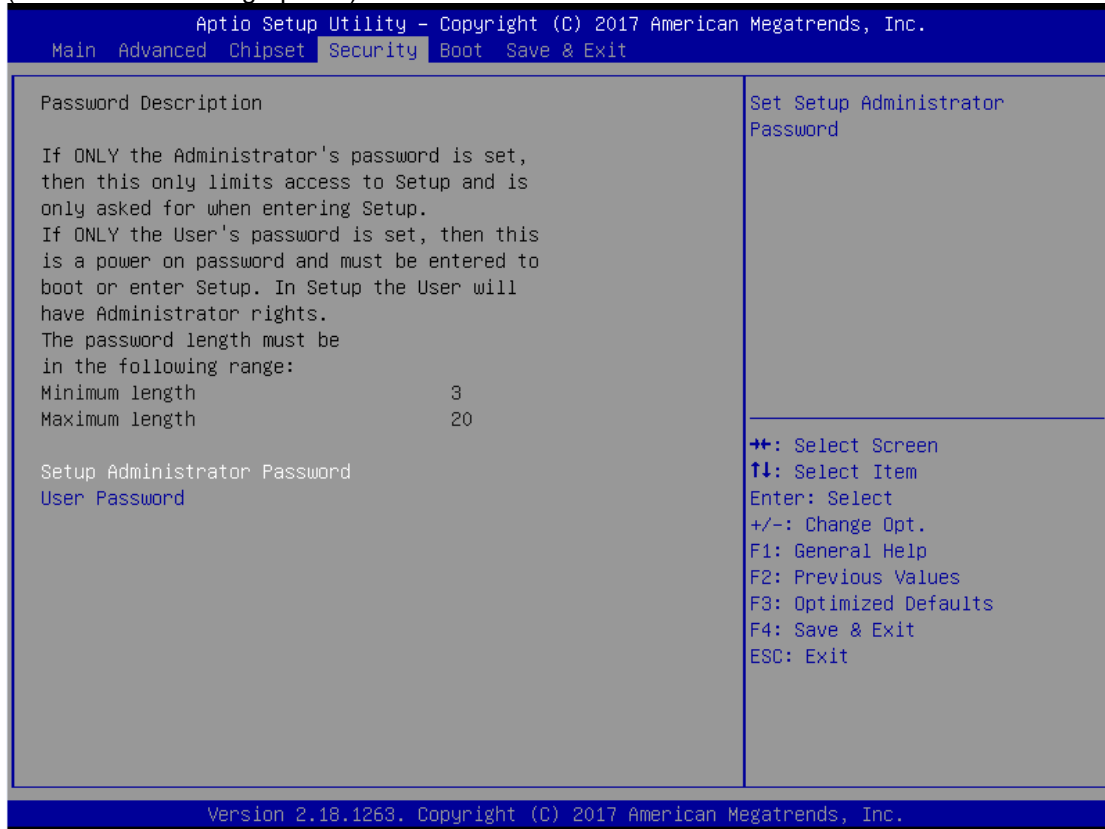

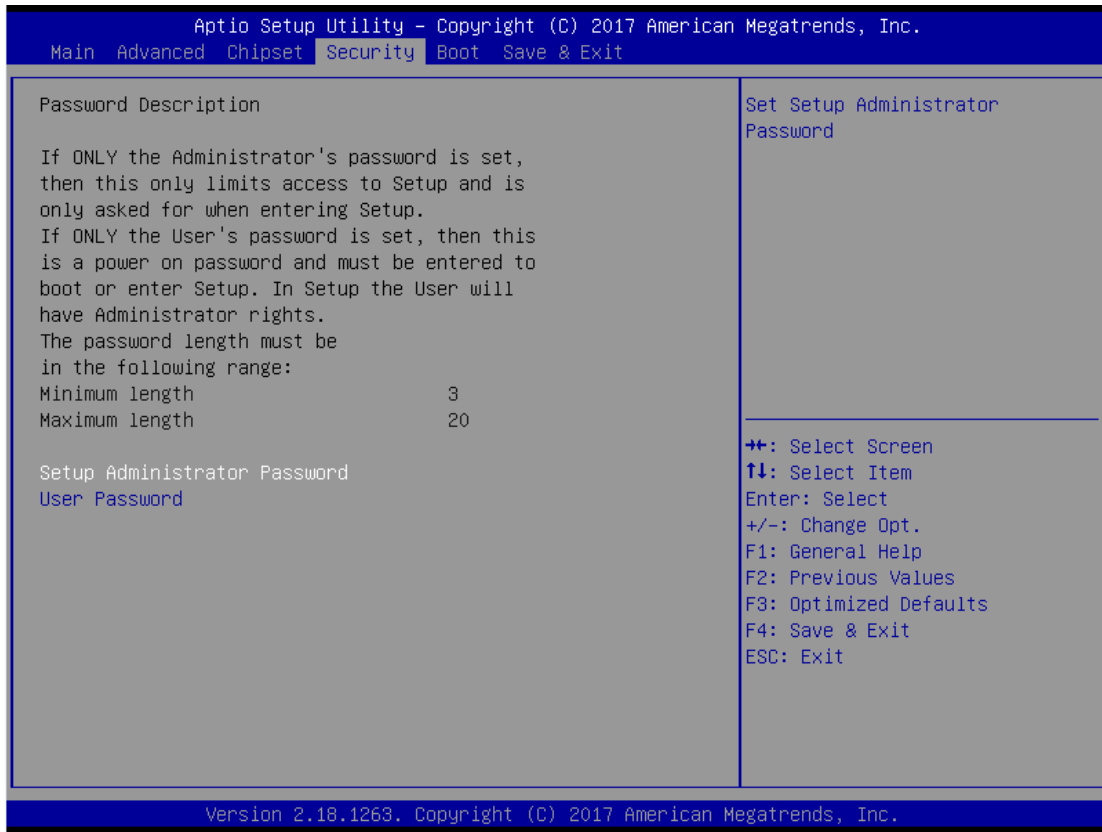

**Note:** The BIOS default has no password, when user created the password, please remember the password number, if users forget password the RMA is the only solution.

### 3.6 Boot Type

Boot have UEFI and Legacy can select .

The default setting boot mode is [UEFI Mode]

(Please refer below graphics.)

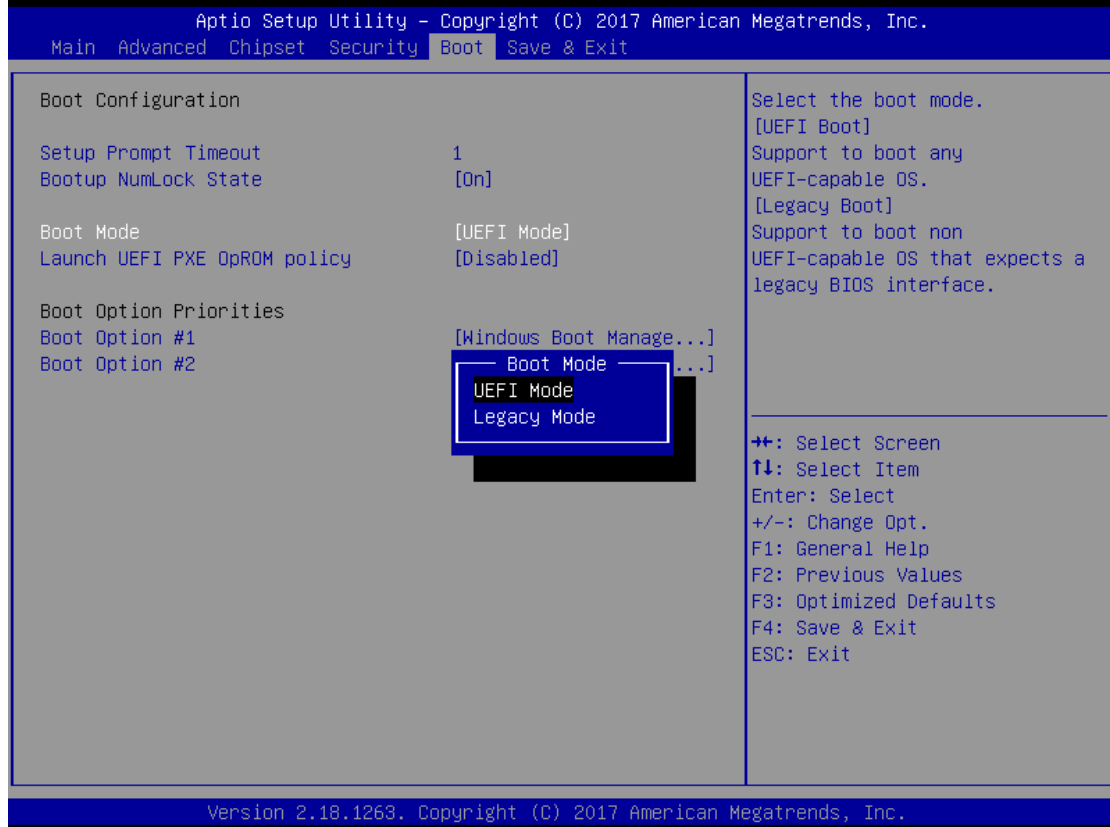

The Boot Option Priorities can select by Boot Option #1, #2...

(Please refer below graphics.)

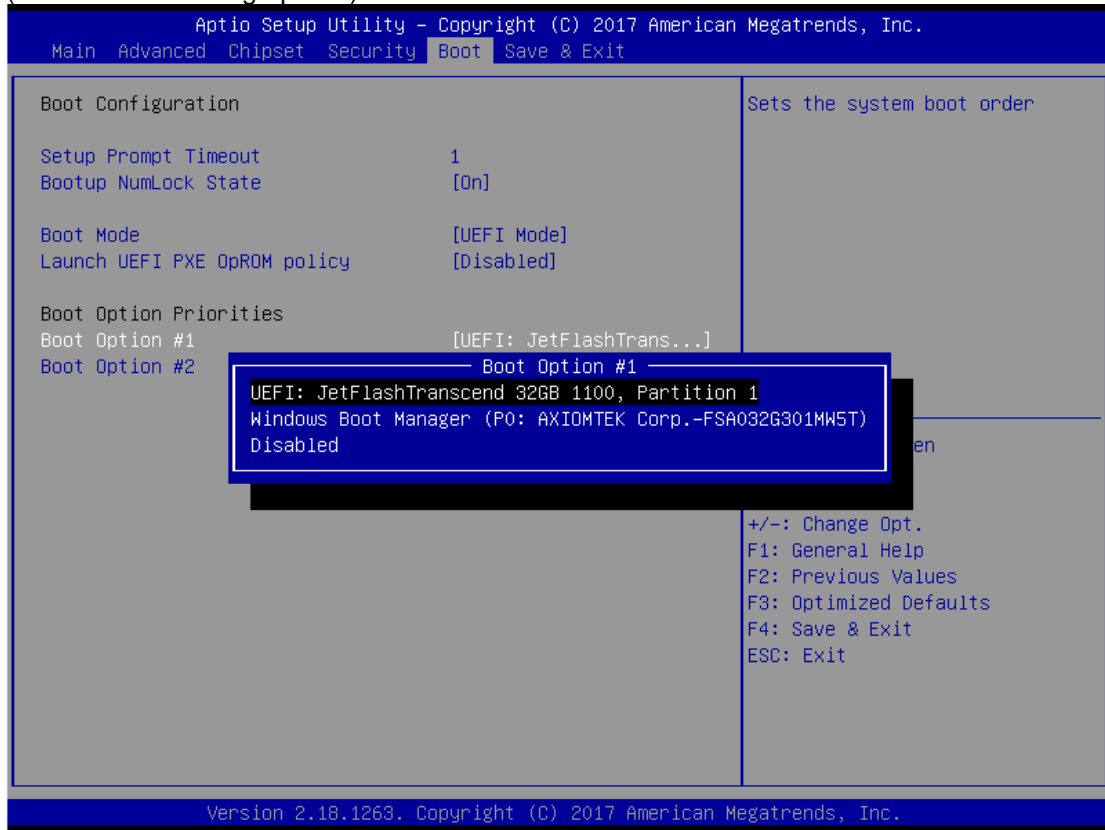



### 3.7 Save & Exit

This section allows you to determine whether or not to accept your modifications. Type “Y” to quit the setup utility and save all changes. Type “N” to bring you back to the Previous Setup utility.

(Please refer below graphics.)

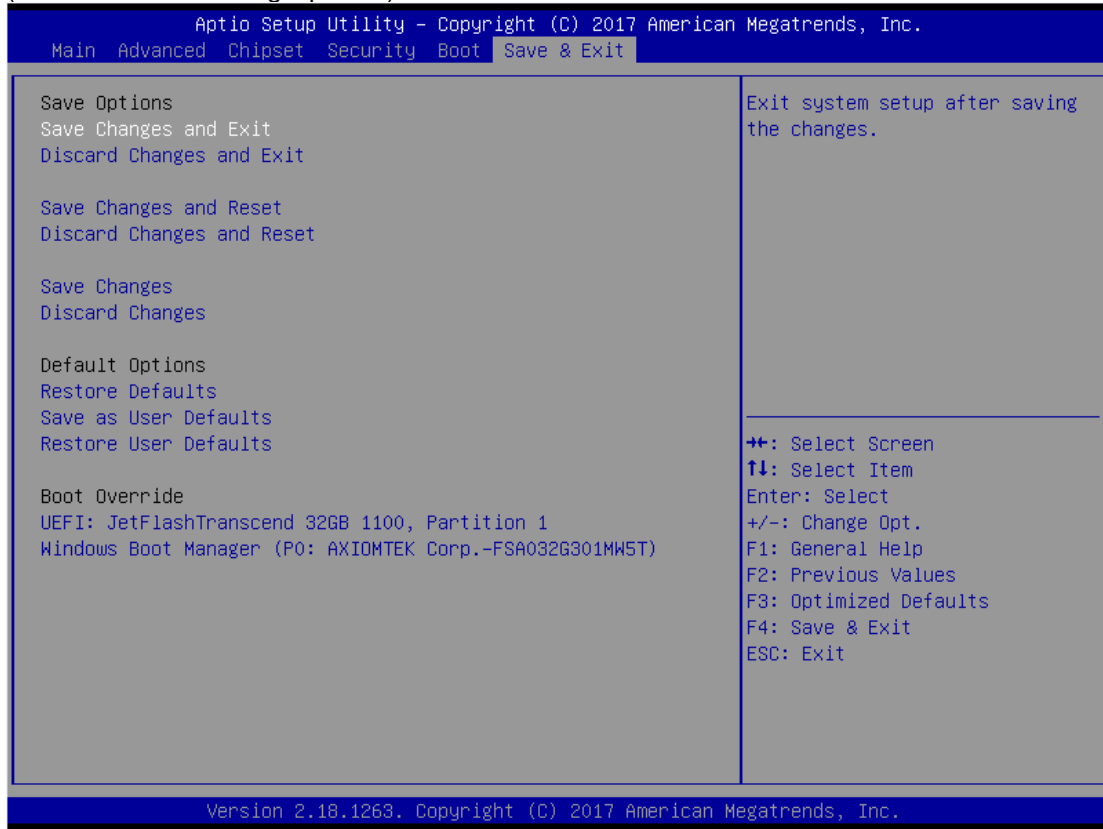

**This page is intentionally left blank.**

## APPENDIX A WATCHDOG TIMER

### About Watchdog Timer

After the system stops working for a while, it can be auto-reset by the watchdog timer. The integrated watchdog timer can be set up in the system reset mode by program.

### How to Use Watchdog Timer

The following example enables configuration using debug tool.

#### Enable WDT

↓

#### Enable configuration:

O 2E 87 ; Un-lock super I/O

O 2E 87

↓

#### Select logic device:

O 2E 07 ; Select logic register

O 2F 07 ; Switch to WDT device

↓

#### Set timer value:

O 2E F6 ; Select logic register

O 2F 05 ; Timer value 0~255 (Sec/Min) (Ex: 5)

↓

#### Clear WDT status (optional):

O 2E F5 ;

O 2F 40

↓

#### Set base timer:

O 2E F5

O 2F M ; M = 28h (Minute)

M = 20h (Second)

**This page is intentionally left blank.**

## APPENDIX B POWER BUTTON SETTING FOR WINDOW SOFTWARE

Please make the power button setting from the console of PC, then follow up below pictures to do the setting.

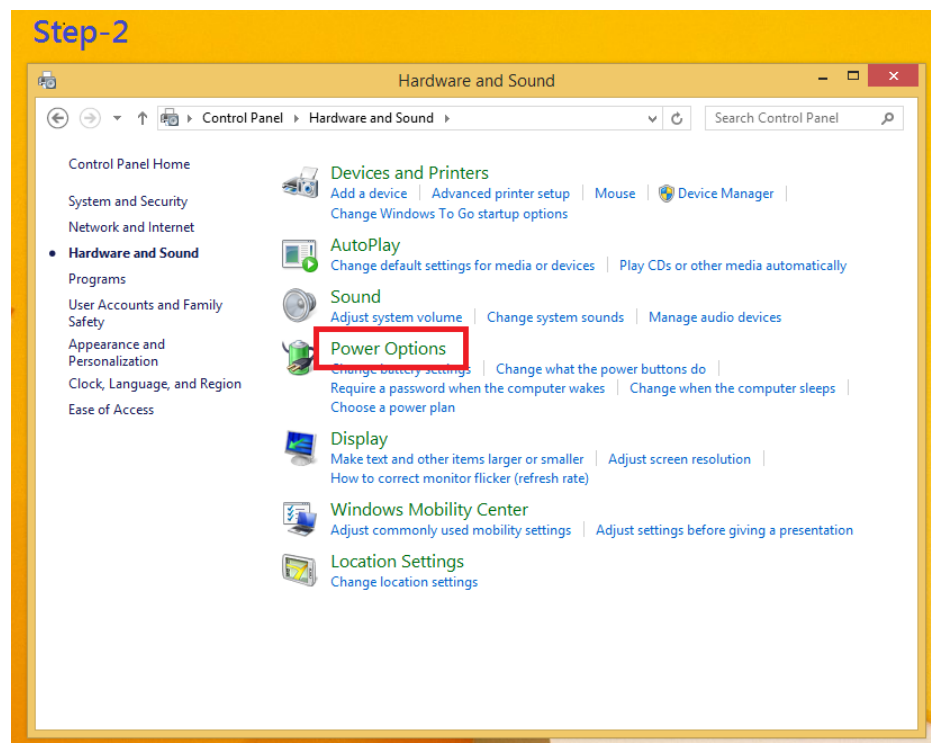
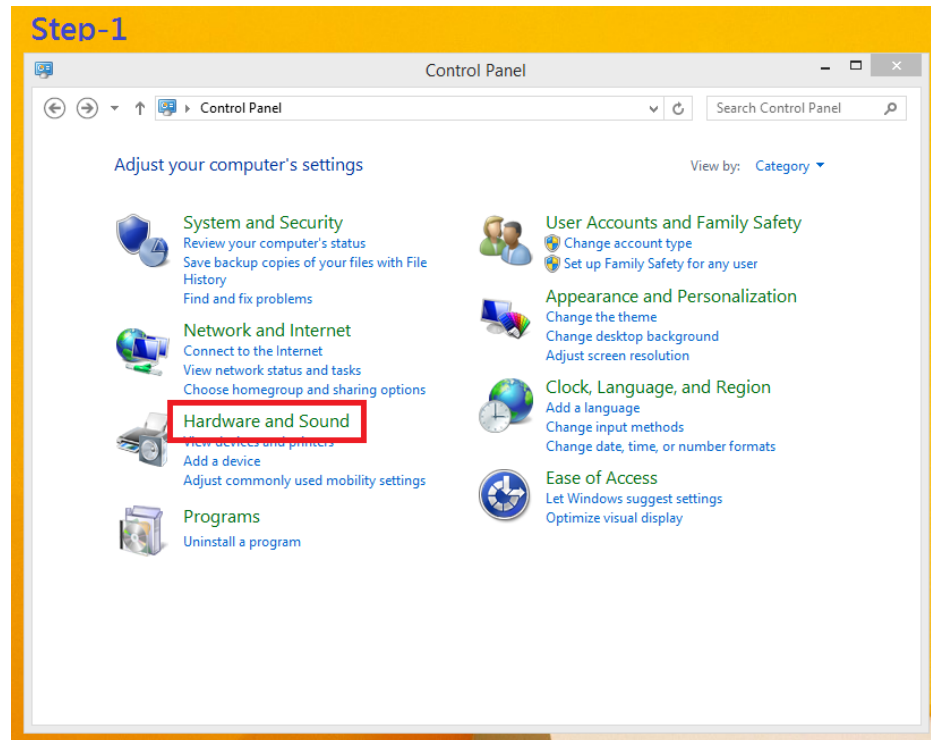

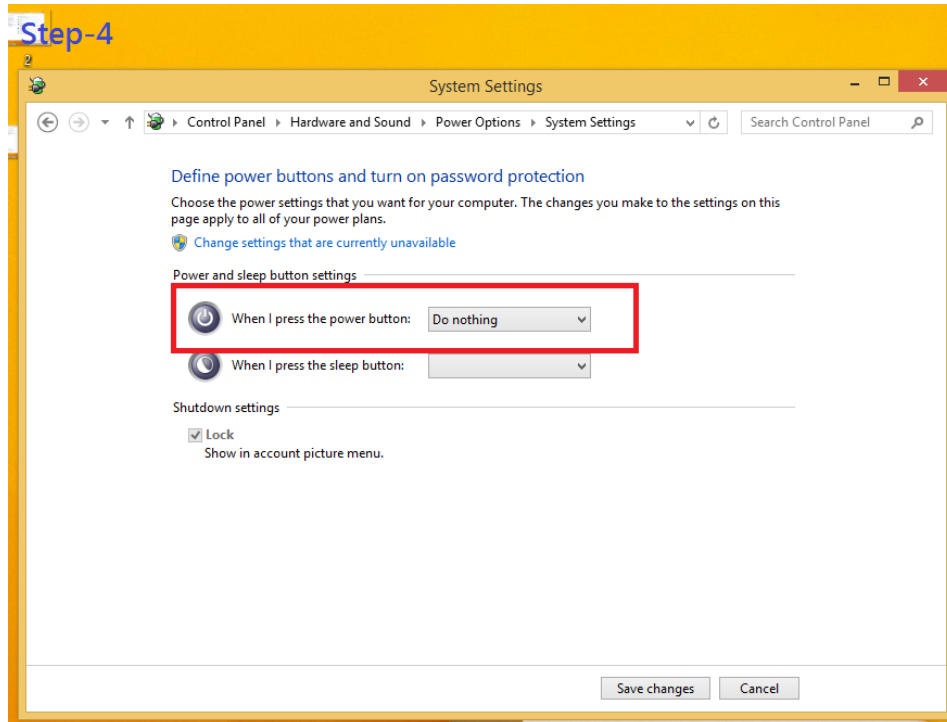
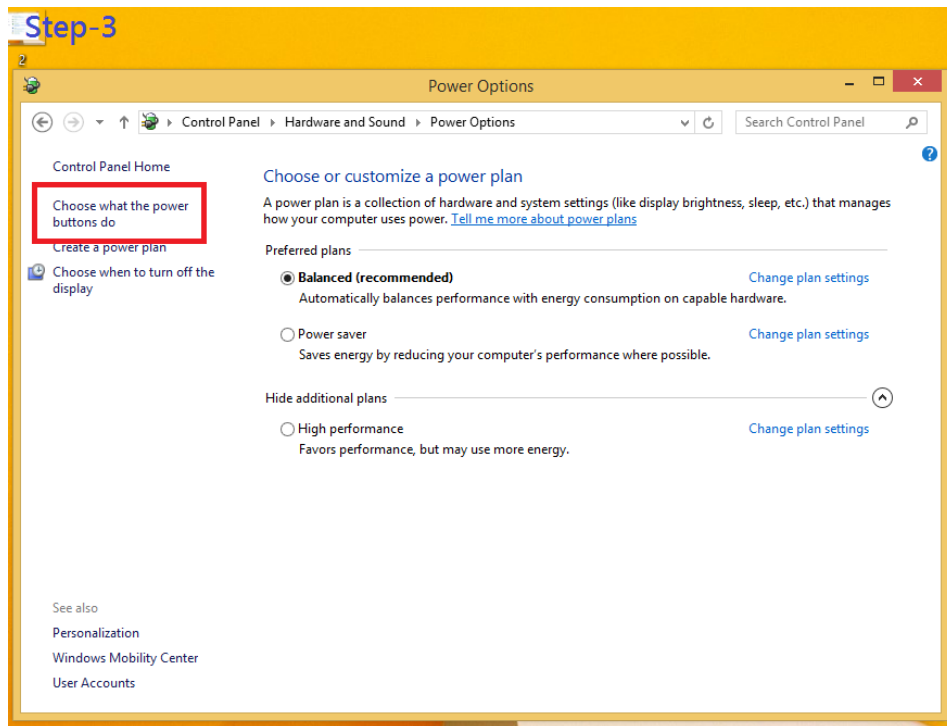

### Step-5

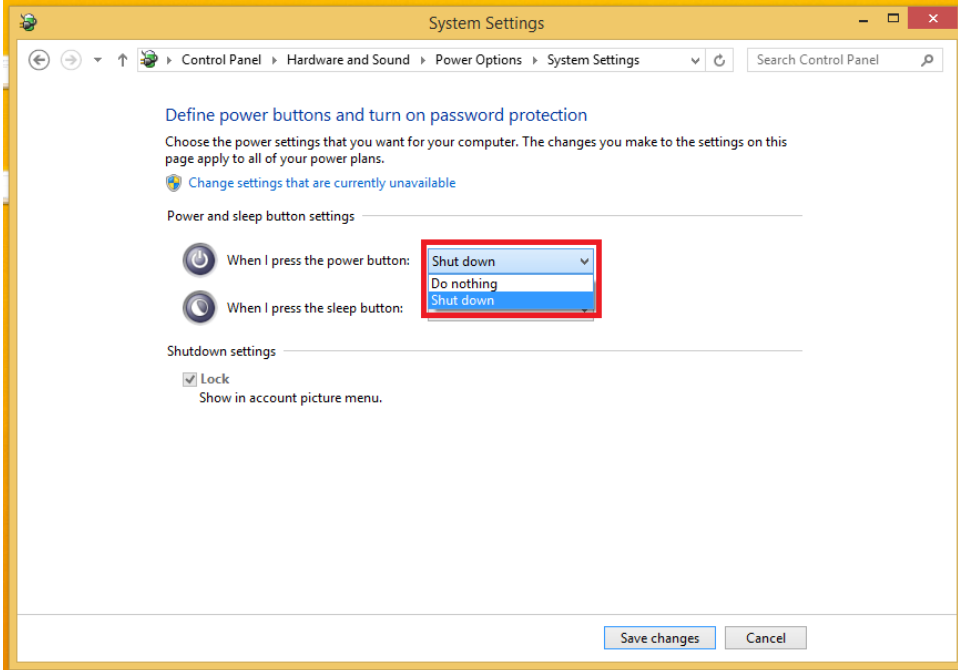

### Step-6

